

Panasonic

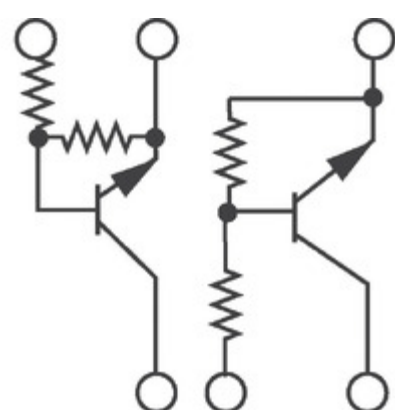

Image may be representation.
See specs for product details.

XP0621500L

Manufacturer Part Number:	XP0621500L
Manufacturer/Brand:	Panasonic
Part of Description:	TRANS PREBIAS DUAL NPN SMINI6
Datasheets:	XP0621500L.pdf
RoHS Status:	Lead free / RoHS
Stock Condition:	Compliant New original, 2622 pcs Stock Available.
Ship From:	Hong Kong
Shipment Way:	DHL/Fedex/TNT/UPS/EMS

Specifications

Part Number	XP0621500L
Manufacturer	Panasonic
Description	TRANS PREBIAS DUAL NPN SMINI6
Category	Discrete Semiconductor Products > Transistors - Bipolar
Part Status	2622 pcs Stock
Voltage - Collector Emitter Breakdown (Max)	50V
Vce Saturation (Max) @ Ib, Ic	250mV @ 300µA, 10mA
Transistor Type	2 NPN - Pre-Biased (Dual)
Supplier Device Package	SMINI6-G1
Series	-
Resistor - Emitter Base (R2) (Ohms)	-
Resistor - Base (R1) (Ohms)	10k
Power - Max	150mW
Packaging	Original-Reel®
Package / Case	6-TSSOP, SC-88, SOT-363
Mounting Type	Surface Mount
Frequency - Transition	150MHz
DC Current Gain (hFE) (Min) @ Ic, Vce	160 @ 5mA, 10V
Current - Collector Cutoff (Max)	500nA
Current - Collector (Ic) (Max)	100mA

You May Be Also Be interested

In:

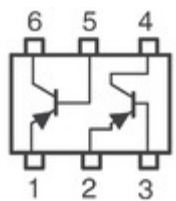

XP0640100L
Panasonic Electronic Components
TRANS 2PNP 50V 0.1A SMINI6

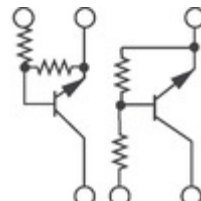

XP0621000L
Panasonic Electronic Components
TRANS PREBIAS DUAL NPN
SMINI6

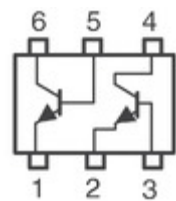

XP0650100L
Panasonic Electronic Components
TRANS 2NPN 50V 0.1A SMINI6

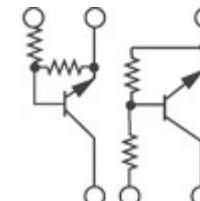

XP0621600L
Panasonic Electronic Components
TRANS PREBIAS DUAL NPN
SMINI6

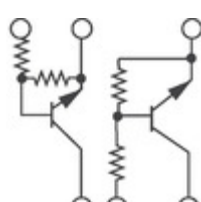

XP0621100L
Panasonic Electronic Components
TRANS PREBIAS DUAL NPN
SMINI6

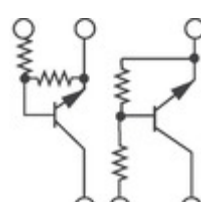

XP0621300L
Panasonic Electronic Components
TRANS PREBIAS DUAL NPN
SMINI6

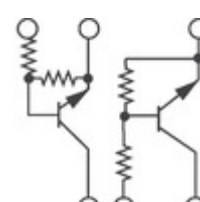

XP0621400L
Panasonic Electronic Components
TRANS PREBIAS DUAL NPN
SMINI6

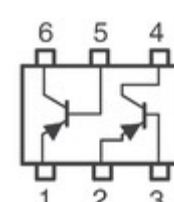

XP0643500L
Panasonic Electronic Components
TRANS 2PNP 20V 0.03A SMINI6

XP0621500L Related keyword

More

XP0621500L Panasonic	XP0621500L Data Sheet	XP0621500L Datasheets	XP0621500L PDF	Panasonic XP0621500L
XP0621500L Electronic	XP0621500L Components	XP0621500L Distributor	XP0621500L Image	XP0621500L Part
XP0621500L Price	XP0621500L Manufacturer	XP0621500L Picture	XP0621500L Stock	XP0621500L Inventory
XP0621500L New	XP0621500L Original	XP0621500L Warranted	XP0621500L RFQ	XP0621500L Order Online

Contact us: Info@YIC-Electronics.com

ADD:Unit A5-B5 No.509, 5/F Sing Win Factory Building, 15-17 Shing yip St, Kwun Tong, Kowloon, HongKong.

Copyright © 2023 YIC-Electronics.com - YIC International Co., Limited