

Panasonic

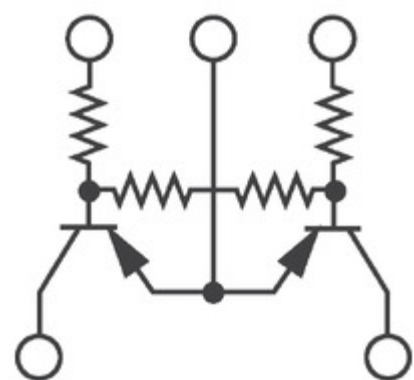

Image may be representation.
See specs for product details.

XP0111500L

Manufacturer Part Number:	XP0111500L
Manufacturer/Brand:	Panasonic
Part of Description:	TRANS PREBIAS DUAL PNP SMINI5
Datasheets:	XP0111500L.pdf
RoHs Status:	Lead free / RoHS
Stock Condition:	Compliant New original, 2578 pcs Stock Available.
Ship From:	Hong Kong
Shipment Way:	DHL/Fedex/TNT/UPS/EMS

Specifications

Part Number	XP0111500L
Manufacturer	Panasonic
Description	TRANS PREBIAS DUAL PNP SMINI5
Category	Discrete Semiconductor Products > Transistors - Bipolar
Part Status	2578 pcs Stock
Voltage - Collector Emitter Breakdown (Max)	50V
Vce Saturation (Max) @ Ib, Ic	250mV @ 300µA, 10mA
Transistor Type	2 PNP - Pre-Biased (Dual)
Supplier Device Package	SMini5-G1
Series	-
Resistor - Emitter Base (R2) (Ohms)	-
Resistor - Base (R1) (Ohms)	10k
Power - Max	150mW
Packaging	Tape & Reel (TR)
Package / Case	5-TSSOP, SC-70-5, SOT-353
Mounting Type	Surface Mount
Frequency - Transition	80MHz
DC Current Gain (hFE) (Min) @ Ic, Vce	160 @ 5mA, 10V
Current - Collector Cutoff (Max)	500nA
Current - Collector (Ic) (Max)	100mA

You May Be Also Be interested

In:



XP01117001MT
PANASONIC
XP01117001MT PANASONIC

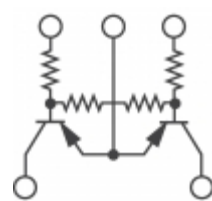

XP0111300L
Panasonic Electronic Components
TRANS PREBIAS DUAL PNP
SMINI5

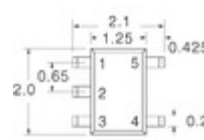

XP0111100L
Panasonic Electronic Components
TRANS PREBIAS DUAL PNP
SMINI5

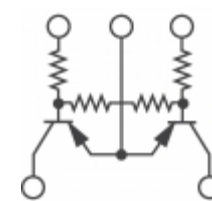

XP0111400L
Panasonic Electronic Components
TRANS PREBIAS DUAL PNP
SMINI5

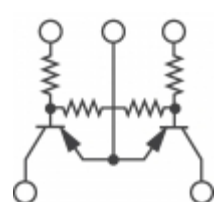

XP0111F00L
Panasonic Electronic Components
TRANS PREBIAS DUAL PNP
SMINI5

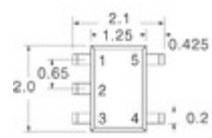

XP0111200L
Panasonic Electronic Components
TRANS PREBIAS DUAL PNP
SMINI5

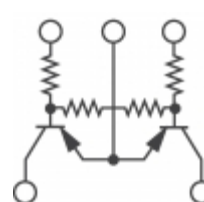

XP0111H00L
Panasonic Electronic Components
TRANS PREBIAS DUAL PNP
SMINI5

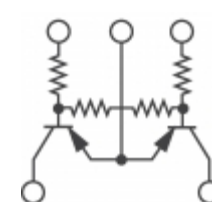

XP0111900L
Panasonic Electronic Components
TRANS PREBIAS DUAL PNP
SMINI5

XP0111500L Related keyword

More

XP0111500L Panasonic	XP0111500L Data Sheet	XP0111500L Datasheets	XP0111500L PDF	Panasonic XP0111500L
XP0111500L Electronic	XP0111500L Components	XP0111500L Distributor	XP0111500L Image	XP0111500L Part
XP0111500L Price	XP0111500L Manufacturer	XP0111500L Picture	XP0111500L Stock	XP0111500L Inventory
XP0111500L New	XP0111500L Original	XP0111500L Warranted	XP0111500L RFQ	XP0111500L Order Online

Contact us: Info@YIC-Electronics.com

ADD:Unit A5-B5 No.509, 5/F Sing Win Factory Building, 15-17 Shing yip St, Kwun Tong, Kowloon, HongKong.

Copyright © 2023 YIC-Electronics.com - YIC International Co., Limited