

**Panasonic**

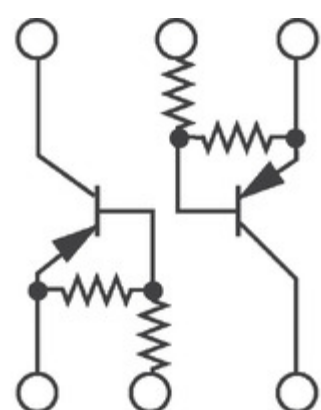

Image may be representation.  
See specs for product details.

## XN0411500L

<b>Manufacturer Part Number:</b>	XN0411500L
<b>Manufacturer/Brand:</b>	Panasonic
<b>Part of Description:</b>	TRANS PREBIAS DUAL PNP MINI6
<b>Datasheets:</b>	<a href="#">PDF XN0411500L.pdf</a>
<b>RoHS Status:</b>	Lead free / RoHS
<b>Stock Condition:</b>	Compliant New original, 2597 pcs Stock Available.
<b>Ship From:</b>	Hong Kong
<b>Shipment Way:</b>	DHL/Fedex/TNT/UPS/EMS

### Specifications

Part Number	XN0411500L
Manufacturer	Panasonic
Description	TRANS PREBIAS DUAL PNP MINI6
Category	Discrete Semiconductor Products > Transistors - Bipolar
Part Status	2597 pcs Stock
Voltage - Collector Emitter Breakdown (Max)	50V
Vce Saturation (Max) @ Ib, Ic	250mV @ 300µA, 10mA
Transistor Type	2 PNP - Pre-Biased (Dual)
Supplier Device Package	MINI6-G1
Series	-
Resistor - Emitter Base (R2) (Ohms)	-
Resistor - Base (R1) (Ohms)	10k
Power - Max	300mW
Packaging	Tape & Reel (TR)
Package / Case	SOT-23-6
Mounting Type	Surface Mount
Frequency - Transition	80MHz
DC Current Gain (hFE) (Min) @ Ic, Vce	160 @ 5mA, 10V
Current - Collector Cutoff (Max)	500nA
Current - Collector (Ic) (Max)	100mA

### You May Be Also Be interested

In:

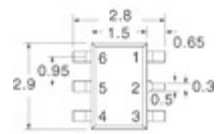

**XN0421200L**  
Panasonic Electronic Components  
TRANS PREBIAS DUAL NPN  
MINI6

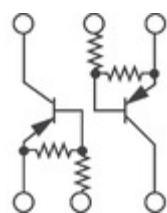

**XN0411100L**  
Panasonic Electronic Components  
TRANS PREBIAS DUAL PNP MINI6

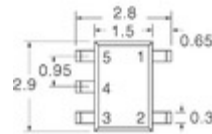

**XN0250100L**  
Panasonic Electronic Components  
TRANS 2NPN 50V 0.1A MINI5

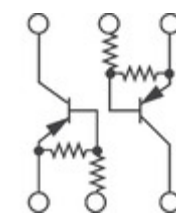

**XN0411600L**  
Panasonic Electronic Components  
TRANS PREBIAS DUAL PNP MINI6



**XN0421000L**  
Panasonic Electronic Components  
TRANS PREBIAS DUAL NPN  
MINI6

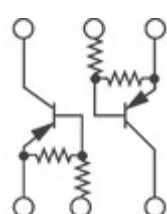

**XN04113000L**  
Panasonic Electronic Components  
TRANS PREBIAS DUAL PNP MINI6

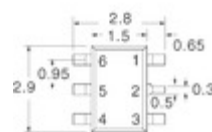

**XN0411400L**  
Panasonic Electronic Components  
TRANS PREBIAS DUAL PNP MINI6



**XN0421100L**  
Panasonic Electronic Components  
TRANS PREBIAS DUAL NPN  
MINI6

### XN0411500L Related keyword

More

XN0411500L Panasonic	XN0411500L Data Sheet	XN0411500L Datasheets	XN0411500L PDF	Panasonic XN0411500L
XN0411500L Electronic	XN0411500L Components	XN0411500L Distributor	XN0411500L Image	XN0411500L Part
XN0411500L Price	XN0411500L Manufacturer	XN0411500L Picture	XN0411500L Stock	XN0411500L Inventory
XN0411500L New	XN0411500L Original	XN0411500L Warranted	XN0411500L RFQ	XN0411500L Order Online

Contact us: [Info@YIC-Electronics.com](mailto:Info@YIC-Electronics.com)

ADD:Unit A5-B5 No.509, 5/F Sing Win Factory Building, 15-17 Shing yip St, Kwun Tong, Kowloon, HongKong.

Copyright © 2023 YIC-Electronics.com - YIC International Co., Limited