



## XP0111M00L

<b>Manufacturer Part Number:</b>	XP0111M00L
<b>Manufacturer/Brand:</b>	Panasonic
<b>Part of Description:</b>	TRANS PREBIAS DUAL PNP SMINI5
<b>Datasheets:</b>	<a href="#">XP0111M00L.pdf</a>
<b>RoHs Status:</b>	Lead free / RoHS
<b>Stock Condition:</b>	Compliant New original, 2419 pcs Stock Available.
<b>Ship From:</b>	Hong Kong
<b>Shipment Way:</b>	DHL/Fedex/TNT/UPS/EMS

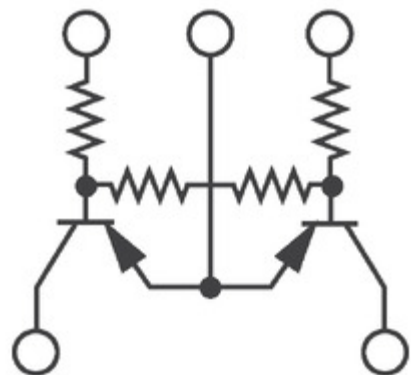

Image may be representation.  
See specs for product details.

### Specifications

Part Number	XP0111M00L
Manufacturer	Panasonic
Description	TRANS PREBIAS DUAL PNP SMINI5
Category	Discrete Semiconductor Products > Transistors - Bipolar
Part Status	2419 pcs Stock
Voltage - Collector Emitter Breakdown (Max)	50V
Vce Saturation (Max) @ Ib, Ic	250mV @ 300µA, 10mA
Transistor Type	2 PNP - Pre-Biased (Dual)
Supplier Device Package	SMini5-G1
Series	-
Resistor - Emitter Base (R2) (Ohms)	47k
Resistor - Base (R1) (Ohms)	2.2k
Power - Max	150mW
Packaging	Original-Reel®
Package / Case	5-TSSOP, SC-70-5, SOT-353
Mounting Type	Surface Mount
Frequency - Transition	80MHz
DC Current Gain (hFE) (Min) @ Ic, Vce	80 @ 5mA, 10V
Current - Collector Cutoff (Max)	500nA
Current - Collector (Ic) (Max)	100mA

### You May Be Also Be interested

In:

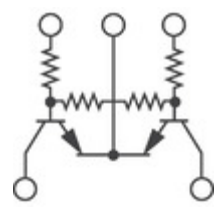

**XP0121300L**  
Panasonic Electronic Components  
TRANS 2NPN PREBIAS 0.15W  
SMINI5

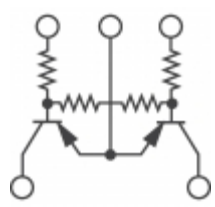

**XP0111H00L**  
Panasonic Electronic Components  
TRANS PREBIAS DUAL PNP  
SMINI5

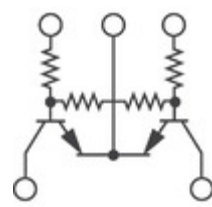

**XP0121200L**  
Panasonic Electronic Components  
TRANS 2NPN PREBIAS 0.15W  
SMINI5

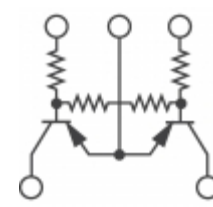

**XP0111F00L**  
Panasonic Electronic Components  
TRANS PREBIAS DUAL PNP  
SMINI5



**XP01117001MT**  
PANASONIC  
XP01117001MT PANASONIC

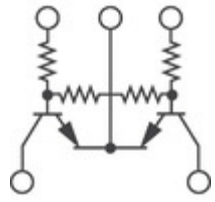

**XP0121100L**  
Panasonic Electronic Components  
TRANS 2NPN PREBIAS 0.15W  
SMINI5

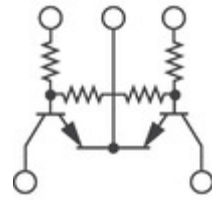

**XP0121400L**  
Panasonic Electronic Components  
TRANS 2NPN PREBIAS 0.15W  
SMINI5

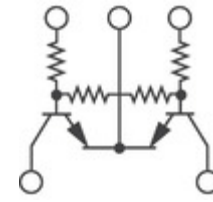

**XP0121000L**  
Panasonic Electronic Components  
TRANS 2NPN PREBIAS 0.15W  
SMINI5

### XP0111M00L Related keyword

More

XP0111M00L Panasonic	XP0111M00L Data Sheet	XP0111M00L Datasheets	XP0111M00L PDF	Panasonic XP0111M00L
XP0111M00L Electronic	XP0111M00L Components	XP0111M00L Distributor	XP0111M00L Image	XP0111M00L Part
XP0111M00L Price	XP0111M00L Manufacturer	XP0111M00L Picture	XP0111M00L Stock	XP0111M00L Inventory
XP0111M00L New	XP0111M00L Original	XP0111M00L Warranted	XP0111M00L RFQ	XP0111M00L Order Online

Contact us: [Info@YIC-Electronics.com](mailto:Info@YIC-Electronics.com)

ADD:Unit A5-B5 No.509, 5/F Sing Win Factory Building, 15-17 Shing yip St, Kwun Tong, Kowloon, HongKong.

Copyright © 2023 YIC-Electronics.com - YIC International Co., Limited