

**Panasonic**

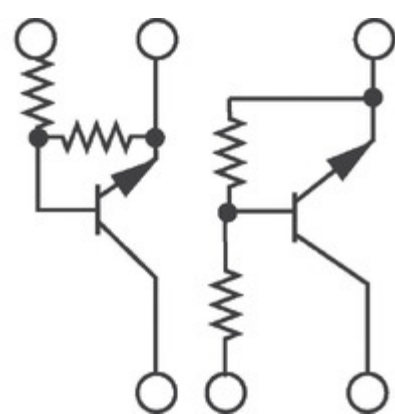

Image may be representation.  
See specs for product details.

## XP0621400L

<b>Manufacturer Part Number:</b>	XP0621400L
<b>Manufacturer/Brand:</b>	Panasonic
<b>Part of Description:</b>	TRANS PREBIAS DUAL NPN SMINI6
<b>Datasheets:</b>	<a href="#">XP0621400L.pdf</a>
<b>RoHs Status:</b>	Lead free / RoHS
<b>Stock Condition:</b>	Compliant New original, 721 pcs Stock Available.
<b>Ship From:</b>	Hong Kong
<b>Shipment Way:</b>	DHL/Fedex/TNT/UPS/EMS

### Specifications

Part Number	XP0621400L
Manufacturer	Panasonic
Description	TRANS PREBIAS DUAL NPN SMINI6
Category	Discrete Semiconductor Products > Transistors - Bipolar
Part Status	721 pcs Stock
Voltage - Collector Emitter Breakdown (Max)	50V
Vce Saturation (Max) @ Ib, Ic	250mV @ 300µA, 10mA
Transistor Type	2 NPN - Pre-Biased (Dual)
Supplier Device Package	SMINI6-G1
Series	-
Resistor - Emitter Base (R2) (Ohms)	47k
Resistor - Base (R1) (Ohms)	10k
Power - Max	150mW
Packaging	Tape & Reel (TR)
Package / Case	6-TSSOP, SC-88, SOT-363
Mounting Type	Surface Mount
Frequency - Transition	150MHz
DC Current Gain (hFE) (Min) @ Ic, Vce	80 @ 5mA, 10V
Current - Collector Cutoff (Max)	500nA
Current - Collector (Ic) (Max)	100mA

### You May Be Also Be interested

In:

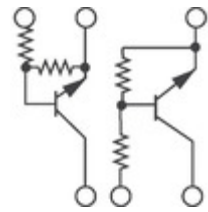

**XP0621200L**  
Panasonic Electronic Components  
TRANS PREBIAS DUAL NPN  
SMINI6

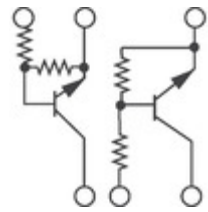

**XP0621100L**  
Panasonic Electronic Components  
TRANS PREBIAS DUAL NPN  
SMINI6

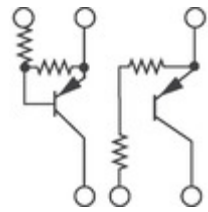

**XP0611500L**  
Panasonic Electronic Components  
TRANS PREBIAS DUAL PNP  
SMINI6

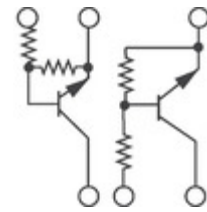

**XP0621300L**  
Panasonic Electronic Components  
TRANS PREBIAS DUAL NPN  
SMINI6

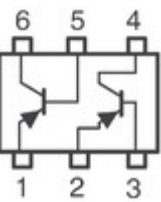

**XP0643500L**  
Panasonic Electronic Components  
TRANS 2PNP 20V 0.03A SMINI6

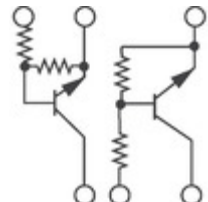

**XP0621500L**  
Panasonic Electronic Components  
TRANS PREBIAS DUAL NPN  
SMINI6

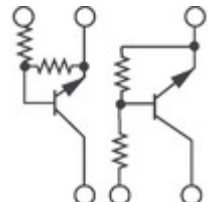

**XP0621000L**  
Panasonic Electronic Components  
TRANS PREBIAS DUAL NPN  
SMINI6

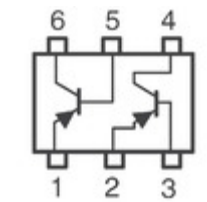

**XP0640100L**  
Panasonic Electronic Components  
TRANS 2PNP 50V 0.1A SMINI6

### XP0621400L Related keyword

More

<a href="#">XP0621400L Panasonic</a>	<a href="#">XP0621400L Data Sheet</a>	<a href="#">XP0621400L Datasheets</a>	<a href="#">XP0621400L PDF</a>	<a href="#">Panasonic XP0621400L</a>
<a href="#">XP0621400L Electronic</a>	<a href="#">XP0621400L Components</a>	<a href="#">XP0621400L Distributor</a>	<a href="#">XP0621400L Image</a>	<a href="#">XP0621400L Part</a>
<a href="#">XP0621400L Price</a>	<a href="#">XP0621400L Manufacturer</a>	<a href="#">XP0621400L Picture</a>	<a href="#">XP0621400L Stock</a>	<a href="#">XP0621400L Inventory</a>
<a href="#">XP0621400L New</a>	<a href="#">XP0621400L Original</a>	<a href="#">XP0621400L Warranted</a>	<a href="#">XP0621400L RFQ</a>	<a href="#">XP0621400L Order Online</a>

Contact us: [Info@YIC-Electronics.com](mailto:Info@YIC-Electronics.com)

ADD:Unit A5-B5 No.509, 5/F Sing Win Factory Building, 15-17 Shing yip St, Kwun Tong, Kowloon, HongKong.

Copyright © 2023 YIC-Electronics.com - YIC International Co., Limited