

Panasonic

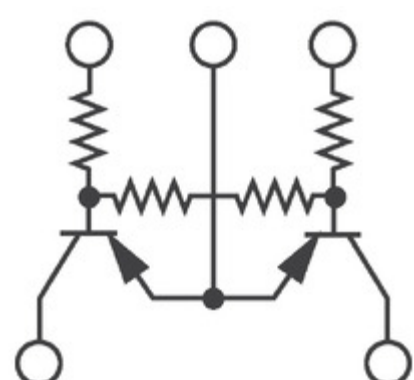

Image may be representation.
See specs for product details.

XP0111300L

Manufacturer Part Number:	XP0111300L
Manufacturer/Brand:	Panasonic
Part of Description:	TRANS PREBIAS DUAL PNP SMINI5
Datasheets:	XP0111300L.pdf
RoHs Status:	Contains lead / RoHS non-compliant
Stock Condition:	New original, 2544 pcs Stock Available.
Ship From:	Hong Kong
Shipment Way:	DHL/Fedex/TNT/UPS/EMS

Specifications

Part Number	XP0111300L
Manufacturer	Panasonic
Description	TRANS PREBIAS DUAL PNP SMINI5
Category	Discrete Semiconductor Products > Transistors - Bipolar
Part Status	2544 pcs Stock
Voltage - Collector Emitter Breakdown (Max)	50V
Vce Saturation (Max) @ Ib, Ic	250mV @ 300µA, 10mA
Transistor Type	2 PNP - Pre-Biased (Dual)
Supplier Device Package	SMini5-G1
Series	-
Resistor - Emitter Base (R2) (Ohms)	47k
Resistor - Base (R1) (Ohms)	47k
Power - Max	150mW
Packaging	Original-Reel®
Package / Case	5-TSSOP, SC-70-5, SOT-353
Mounting Type	Surface Mount
Frequency - Transition	80MHz
DC Current Gain (hFE) (Min) @ Ic, Vce	80 @ 5mA, 10V
Current - Collector Cutoff (Max)	500nA
Current - Collector (Ic) (Max)	100mA

You May Be Also Be interested

In:



XP01117001MT
PANASONIC
XP01117001MT PANASONIC

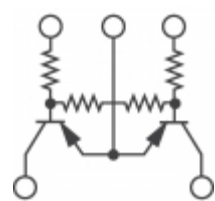

XP0111H00L
Panasonic Electronic Components
TRANS PREBIAS DUAL PNP
SMINI5

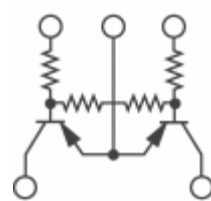

XP0111000L
Panasonic Electronic Components
TRANS PREBIAS DUAL PNP
SMINI5



XP0111200L
Panasonic Electronic Components
TRANS PREBIAS DUAL PNP
SMINI5

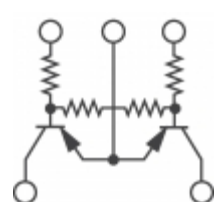

XP0111400L
Panasonic Electronic Components
TRANS PREBIAS DUAL PNP
SMINI5

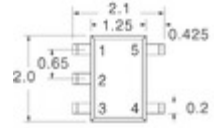

XP0111100L
Panasonic Electronic Components
TRANS PREBIAS DUAL PNP
SMINI5

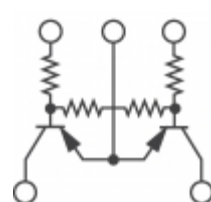

XP0111900L
Panasonic Electronic Components
TRANS PREBIAS DUAL PNP
SMINI5

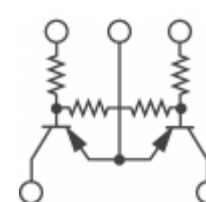

XP0111500L
Panasonic Electronic Components
TRANS PREBIAS DUAL PNP
SMINI5

XP0111300L Related keyword

More

XP0111300L Panasonic	XP0111300L Data Sheet	XP0111300L Datasheets	XP0111300L PDF	Panasonic XP0111300L
XP0111300L Electronic	XP0111300L Components	XP0111300L Distributor	XP0111300L Image	XP0111300L Part
XP0111300L Price	XP0111300L Manufacturer	XP0111300L Picture	XP0111300L Stock	XP0111300L Inventory
XP0111300L New	XP0111300L Original	XP0111300L Warranted	XP0111300L RFQ	XP0111300L Order Online

Contact us: Info@YIC-Electronics.com

ADD:Unit A5-B5 No.509, 5/F Sing Win Factory Building, 15-17 Shing yip St, Kwun Tong, Kowloon, HongKong.

Copyright © 2023 YIC-Electronics.com - YIC International Co., Limited