



XN0111400L

Manufacturer Part Number:	XN0111400L
Manufacturer/Brand:	Panasonic
Part of Description:	TRANS PREBIAS DUAL PNP MINI5
Datasheets:	XN0111400L.pdf
RoHS Status:	Lead free / RoHS
Stock Condition:	Compliant New original, 2504 pcs Stock Available.
Ship From:	Hong Kong
Shipment Way:	DHL/Fedex/TNT/UPS/EMS

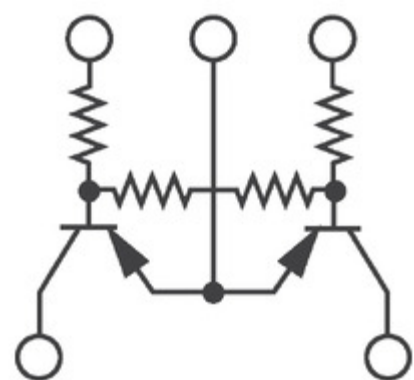

Image may be representation.
See specs for product details.

Specifications

Part Number	XN0111400L
Manufacturer	Panasonic
Description	TRANS PREBIAS DUAL PNP MINI5
Category	Discrete Semiconductor Products > Transistors - Bipolar
Part Status	2504 pcs Stock
Voltage - Collector Emitter Breakdown (Max)	50V
Vce Saturation (Max) @ Ib, Ic	250mV @ 300µA, 10mA
Transistor Type	2 PNP - Pre-Biased (Dual)
Supplier Device Package	Mini5-G1
Series	-
Resistor - Emitter Base (R2) (Ohms)	47k
Resistor - Base (R1) (Ohms)	10k
Power - Max	300mW
Packaging	Tape & Reel (TR)
Package / Case	SC-74A, SOT-753
Mounting Type	Surface Mount
Frequency - Transition	80MHz
DC Current Gain (hFE) (Min) @ Ic, Vce	80 @ 5mA, 10V
Current - Collector Cutoff (Max)	500nA
Current - Collector (Ic) (Max)	100mA

You May Be Also Be interested

In:

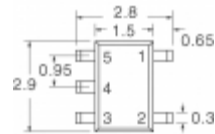

XN0111300L
Panasonic Electronic Components
TRANS PREBIAS DUAL PNP MINI5

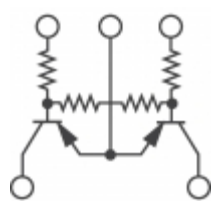

XN0111200L
Panasonic Electronic Components
TRANS PREBIAS DUAL PNP MINI5

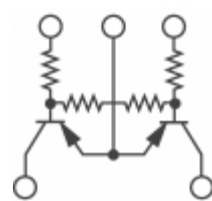

XN0111500L
Panasonic Electronic Components
TRANS PREBIAS DUAL PNP MINI5

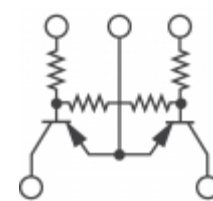

XN0111000L
Panasonic Electronic Components
TRANS PREBIAS DUAL PNP MINI5



XN009D5700L
PANASONIC
PANASONIC SOT23-6

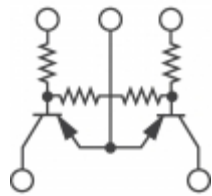

XN0111600L
Panasonic Electronic Components
TRANS PREBIAS DUAL PNP MINI5

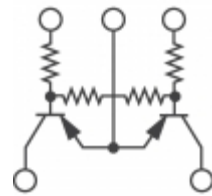

XN0111F00L
Panasonic Electronic Components
TRANS PREBIAS DUAL PNP MINI5

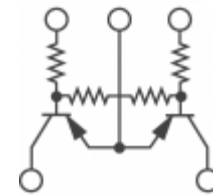

XN0111100L
Panasonic Electronic Components
TRANS PREBIAS DUAL PNP MINI5

XN0111400L Related keyword

More

XN0111400L Panasonic	XN0111400L Data Sheet	XN0111400L Datasheets	XN0111400L PDF	Panasonic XN0111400L
XN0111400L Electronic	XN0111400L Components	XN0111400L Distributor	XN0111400L Image	XN0111400L Part
XN0111400L Price	XN0111400L Manufacturer	XN0111400L Picture	XN0111400L Stock	XN0111400L Inventory
XN0111400L New	XN0111400L Original	XN0111400L Warranted	XN0111400L RFQ	XN0111400L Order Online

Contact us: Info@YIC-Electronics.com

ADD:Unit A5-B5 No.509, 5/F Sing Win Factory Building, 15-17 Shing yip St, Kwun Tong, Kowloon, HongKong.

Copyright © 2023 YIC-Electronics.com - YIC International Co., Limited