



XP0111H00L

Manufacturer Part Number:	XP0111H00L
Manufacturer/Brand:	Panasonic
Part of Description:	TRANS PREBIAS DUAL PNP SMINI5
Datasheets:	XP0111H00L.pdf
RoHs Status:	Contains lead / RoHS non-compliant
Stock Condition:	New original, 2660 pcs Stock Available.
Ship From:	Hong Kong
Shipment Way:	DHL/Fedex/TNT/UPS/EMS

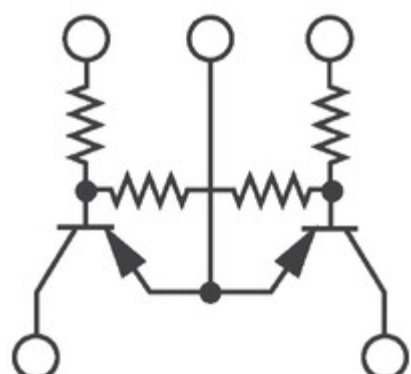

Image may be representation.
See specs for product details.

Specifications

Part Number	XP0111H00L
Manufacturer	Panasonic
Description	TRANS PREBIAS DUAL PNP SMINI5
Category	Discrete Semiconductor Products > Transistors - Bipolar
Part Status	2660 pcs Stock
Voltage - Collector Emitter Breakdown (Max)	50V
Vce Saturation (Max) @ Ib, Ic	250mV @ 300µA, 10mA
Transistor Type	2 PNP - Pre-Biased (Dual)
Supplier Device Package	SMini5-G1
Series	-
Resistor - Emitter Base (R2) (Ohms)	10k
Resistor - Base (R1) (Ohms)	2.2k
Power - Max	150mW
Packaging	Tape & Reel (TR)
Package / Case	5-TSSOP, SC-70-5, SOT-353
Mounting Type	Surface Mount
Frequency - Transition	80MHz
DC Current Gain (hFE) (Min) @ Ic, Vce	30 @ 5mA, 10V
Current - Collector Cutoff (Max)	500nA
Current - Collector (Ic) (Max)	100mA

You May Be Also Be interested

In:

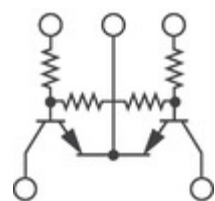

XP0121200L
Panasonic Electronic Components
TRANS 2NPN PREBIAS 0.15W
SMINI5

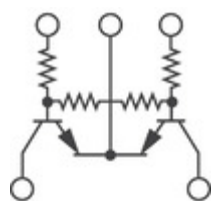

XP0121000L
Panasonic Electronic Components
TRANS 2NPN PREBIAS 0.15W
SMINI5

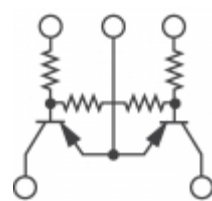

XP0111500L
Panasonic Electronic Components
TRANS PREBIAS DUAL PNP
SMINI5

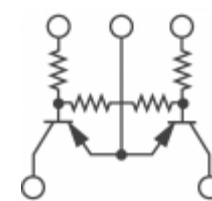

XP0111900L
Panasonic Electronic Components
TRANS PREBIAS DUAL PNP
SMINI5



XP01117001MT
PANASONIC
XP01117001MT PANASONIC

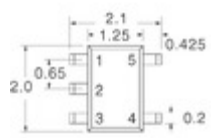

XP0111600L
Panasonic Electronic Components
TRANS PREBIAS DUAL PNP
SMINI5



XP0111L00L
PANASONIC
PANASONIC SOT353

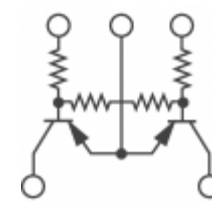

XP0111M00L
Panasonic Electronic Components
TRANS PREBIAS DUAL PNP
SMINI5

XP0111H00L Related keyword

More

XP0111H00L Panasonic	XP0111H00L Data Sheet	XP0111H00L Datasheets	XP0111H00L PDF	Panasonic XP0111H00L
XP0111H00L Electronic	XP0111H00L Components	XP0111H00L Distributor	XP0111H00L Image	XP0111H00L Part
XP0111H00L Price	XP0111H00L Manufacturer	XP0111H00L Picture	XP0111H00L Stock	XP0111H00L Inventory
XP0111H00L New	XP0111H00L Original	XP0111H00L Warranted	XP0111H00L RFQ	XP0111H00L Order Online

Contact us: Info@YIC-Electronics.com

ADD: Unit A5-B5 No.509, 5/F Sing Win Factory Building, 15-17 Shing yip St, Kwun Tong, Kowloon, HongKong.

Copyright © 2023 YIC-Electronics.com - YIC International Co., Limited