

Panasonic

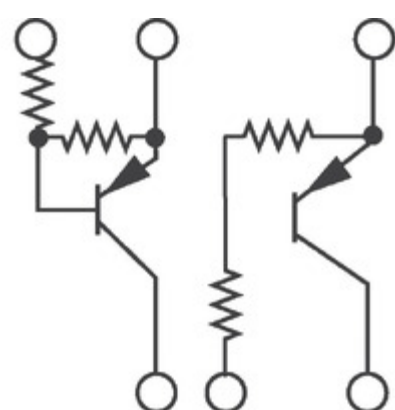

Image may be representation.
See specs for product details.

XN0621600L

Manufacturer Part Number:	XN0621600L
Manufacturer/Brand:	Panasonic
Part of Description:	TRANS PREBIAS DUAL NPN MINI6
Datasheets:	XN0621600L.pdf
RoHs Status:	Contains lead / RoHS non-compliant
Stock Condition:	New original, 2572 pcs Stock Available.
Ship From:	Hong Kong
Shipment Way:	DHL/Fedex/TNT/UPS/EMS

Specifications

Part Number	XN0621600L
Manufacturer	Panasonic
Description	TRANS PREBIAS DUAL NPN MINI6
Category	Discrete Semiconductor Products > Transistors - Bipolar
Part Status	2572 pcs Stock
Voltage - Collector Emitter Breakdown (Max)	50V
Vce Saturation (Max) @ Ib, Ic	250mV @ 300µA, 10mA
Transistor Type	2 NPN - Pre-Biased (Dual)
Supplier Device Package	MINI6-G1
Series	-
Resistor - Emitter Base (R2) (Ohms)	-
Resistor - Base (R1) (Ohms)	4.7k
Power - Max	300mW
Packaging	Original-Reel®
Package / Case	SOT-23-6
Mounting Type	Surface Mount
Frequency - Transition	150MHz
DC Current Gain (hFE) (Min) @ Ic, Vce	160 @ 5mA, 10V
Current - Collector Cutoff (Max)	500nA
Current - Collector (Ic) (Max)	100mA

You May Be Also Be interested

In:

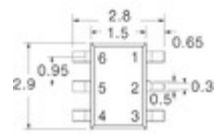

XN0640100L
Panasonic Electronic Components
TRANS 2PNP 50V 0.1A MINI6

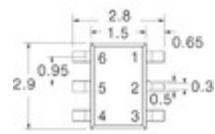

XN0643500L
Panasonic Electronic Components
TRANS 2PNP 20V 0.03A MINI6

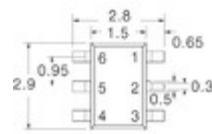

XN0653700L
Panasonic Electronic Components
TRANS 2NPN 12V 0.03A MINI6



XN0560100L(XN5601-TX)
Panasonic
XN0560100L(XN5601-TX)
Panasonic



XN0621300L
Panasonic Electronic Components
TRANS PREBIAS DUAL NPN
MINI6

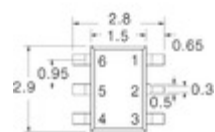

XN0650100L
Panasonic Electronic Components
TRANS 2NPN 50V 0.1A MINI6

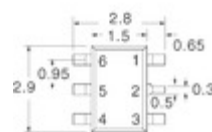

XN0621500L
Panasonic Electronic Components
TRANS PREBIAS DUAL NPN
MINI6

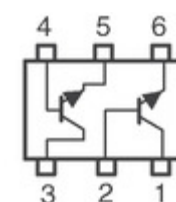

XN0653400L
Panasonic Electronic Components
TRANS 2NPN 20V 0.015A MINI6

XN0621600L Related keyword

More

XN0621600L Panasonic	XN0621600L Data Sheet	XN0621600L Datasheets	XN0621600L PDF	Panasonic XN0621600L
XN0621600L Electronic	XN0621600L Components	XN0621600L Distributor	XN0621600L Image	XN0621600L Part
XN0621600L Price	XN0621600L Manufacturer	XN0621600L Picture	XN0621600L Stock	XN0621600L Inventory
XN0621600L New	XN0621600L Original	XN0621600L Warranted	XN0621600L RFQ	XN0621600L Order Online

Contact us: Info@YIC-Electronics.com

ADD:Unit A5-B5 No.509, 5/F Sing Win Factory Building, 15-17 Shing yip St, Kwun Tong, Kowloon, HongKong.

Copyright © 2023 YIC-Electronics.com - YIC International Co., Limited