

## Resonant Mode Combi IGBT®

The Thunderbolt HS™ IGBT used in this resonant mode combi is based on thin wafer non-punch through (NPT) technology similar to the Thunderbolt® series, but trades higher  $V_{CE(ON)}$  for significantly lower turn-on energy  $E_{off}$ . The low switching losses enable operation at switching frequencies over 100kHz, approaching power MOSFET performance but lower cost.

An extremely tight parameter distribution combined with a positive  $V_{CE(ON)}$  temperature coefficient make it easy to parallel Thunderbolts HS™ IGBT's. Controlled slew rates result in very good noise and oscillation immunity and low EMI. The short circuit duration rating of 10 $\mu$ s make these IGBT's suitable for motor drive and inverter applications. Reliability is further enhanced by avalanche energy ruggedness. Combi versions are packaged with a high speed, soft recovery DL series diode.

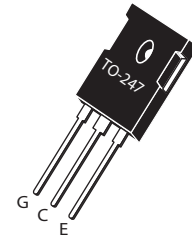

Single die IGBT with separate DL



### Features

- Fast Switching with low EMI
- Very Low  $E_{OFF}$  for Maximum Efficiency
- Short circuit rated
- Low Gate Charge
- RoHS Compliant 
- Tight parameter distribution
- Easy paralleling
- Low Forward Diode Voltage (VF)
- Ultrasoft Recovery Diode

### Typical Applications

- ZVS Phase Shifted Bridge
- Resonant Mode Switching
- Phase Shifted Bridge
- Welding
- Induction heating
- High Frequency SMPS

### Absolute Maximum Ratings

| Symbol   | Parameter  | Rating    | Unit    |
|----------|--|-----------|---------|
| $I_{C1}$ | Continuous Collector Current $T_C = @ 25^\circ C$  | 93        | A       |
| $I_{C2}$ | Continuous Collector Current $T_C = @ 100^\circ C$ | 50        |         |
| $I_{CM}$ | Pulsed Collector Current <sup>①</sup>              | 195       |         |
| $V_{GE}$ | Gate-Emitter Voltage                               | $\pm 30V$ | V       |
| SSOA     | Switching Safe Operating Area                      | 195       |         |
| $t_{SC}$ | Short Circuit Withstand Time <sup>③</sup>          | 10        | $\mu s$ |

### Thermal and Mechanical Characteristics

| Symbol          | Parameter  | Min   | Typ  | Max  | Unit         |
|-----------------|--|-------|------|------|--------------|
| $P_D$           | Total Power Dissipation $T_C = @ 25^\circ C$           | -     | -    | 415  | W            |
| $R_{\theta JC}$ | Junction to Case Thermal Resistance                    | IGBT  | -    | 0.30 | $^\circ C/W$ |
|                 |  | Diode | -    | 0.63 |              |
| $R_{\theta CS}$ | Case to Sink Thermal Resistance, Flat Greased Surface  | -     | 0.11 | -    |              |
| $T_J, T_{STG}$  | Operating and Storage Junction Temperature Range       | -55   | -    | 150  | $^\circ C$   |
| $T_L$           | Soldering Temperature for 10 Seconds (1.6mm from case) | -     | -    | 300  |              |
| $W_T$           | Package Weight   | -     | 0.22 | -    | oz           |
|                 |  | -     | 5.9  | -    | g            |
| Torque          | Mounting Torque (TO-247), 6-32 M3 Screw                | -     | -    | 10   | in·lbf       |
|                 |  | -     | -    | 1.1  | N·m          |

 **CAUTION:** These Devices are Sensitive to Electrostatic Discharge. Proper Handling Procedures Should be Followed.

**Static Characteristics**
**T<sub>J</sub> = 25°C unless otherwise specified**
**APT50GS60BRDL(G)**

| Symbol                                 | Parameter                                 | Test Conditions  | Min                    | Typ  | Max  | Unit  |    |
|--|---|--|------------------------|------|------|-------|----|
| V <sub>BR(CES)</sub>                   | Collector-Emitter Breakdown Voltage       | V <sub>GE</sub> = 0V, I <sub>C</sub> = 250μA             | 600                    | -    | -    | V     |    |
| ΔV <sub>BR(CES)</sub> /ΔT <sub>J</sub> | Breakdown Voltage Temperature Coeff       | Reference to 25°C, I <sub>C</sub> = 250μA                | -                      | 0.60 | -    | V/°C  |    |
| V <sub>CE(ON)</sub>                    | Collector-Emitter On Voltage <sup>④</sup> | V <sub>GE</sub> = 15V<br>I <sub>C</sub> = 50A            | T <sub>J</sub> = 25°C  | -    | 2.8  | 3.15  | V  |
|  |   |  | T <sub>J</sub> = 125°C | -    | 3.25 | -     |    |
| V <sub>GE(th)</sub>                    | Gate-Emitter Threshold Voltage            | V <sub>GE</sub> = V <sub>CE</sub> , I <sub>C</sub> = 1mA | 3                      | 4    | 5    | mV/°C |    |
| ΔV <sub>GE(th)</sub> /ΔT <sub>J</sub>  | Threshold Voltage Temp Coeff              |  | -                      | 6.7  | -    |       |    |
| I <sub>CES</sub>                       | Zero Gate Voltage Collector Current       | V <sub>CE</sub> = 600V,<br>V <sub>GE</sub> = 0V          | T <sub>J</sub> = 25°C  | -    | -    | 50    | μA |
|  |   |  | T <sub>J</sub> = 125°C | -    | -    | 1000  |    |
| I <sub>GES</sub>                       | Gate-Emitter Leakage Current              | V <sub>GE</sub> = ±20V                                   | -                      | -    | ±100 | nA    |    |

**Dynamic Characteristics**
**T<sub>J</sub> = 25°C unless otherwise specified**

| Symbol              | Parameter   | Test Conditions  | Min | Typ   | Max | Unit |
|---------------------|---|--|-----|-------|-----|------|
| g <sub>fs</sub>     | Forward Transconductance                                  | V <sub>CE</sub> = 50V, I <sub>C</sub> = 50A  | -   | 31    | -   | S    |
| C <sub>ies</sub>    | Input Capacitance   | V <sub>GE</sub> = 0V, V <sub>CE</sub> = 25V<br>f = 1MHz  | -   | 2635  | -   | pF   |
| C <sub>oes</sub>    | Output Capacitance  |  | -   | 240   | -   |      |
| C <sub>res</sub>    | Reverse Transfer Capacitance                              |  | -   | 145   | -   |      |
| C <sub>o(cr)</sub>  | Reverse Transfer Capacitance Charge Related <sup>⑤</sup>  | V <sub>GE</sub> = 0V<br>V <sub>CE</sub> = 0 to 400V  | -   | 115   | -   |      |
| C <sub>o(er)</sub>  | Reverse Transfer Capacitance Current Related <sup>⑥</sup> |  | -   | 85    | -   |      |
| Q <sub>g</sub>      | Total Gate Charge   | V <sub>GE</sub> = 0 to 15V<br>I <sub>C</sub> = 50A, V <sub>CE</sub> = 300V   | -   | 235   | -   | nC   |
| Q <sub>ge</sub>     | Gate-Emitter Charge                                       |  | -   | 18    | -   |      |
| G <sub>gc</sub>     | Gate-Collector Charge                                     |  | -   | 100   | -   |      |
| t <sub>d(on)</sub>  | Turn-On Delay Time  | Inductive Switching IGBT and Diode:<br><br>T <sub>J</sub> = 25°C, V <sub>CC</sub> = 400V,<br>I <sub>C</sub> = 50A<br>R <sub>G</sub> = 4.7Ω <sup>⑦</sup> , V <sub>GG</sub> = 15V  | -   | 16    | -   | ns   |
| t <sub>r</sub>      | Rise Time   |  | -   | 33    | -   |      |
| t <sub>d(off)</sub> | Turn-Off Delay Time                                       |  | -   | 225   | -   |      |
| t <sub>f</sub>      | Fall Time   |  | -   | 37    | -   |      |
| E <sub>on1</sub>    | Turn-On Switching Energy <sup>⑧</sup>                     | Inductive Switching IGBT and Diode:<br><br>T <sub>J</sub> = 125°C, V <sub>CC</sub> = 400V,<br>I <sub>C</sub> = 50A<br>R <sub>G</sub> = 4.7Ω <sup>⑦</sup> , V <sub>GG</sub> = 15V | -   | TBD   | -   | mJ   |
| E <sub>on2</sub>    | Turn-On Switching Energy <sup>⑨</sup>                     |  | -   | 1.2   | -   |      |
| E <sub>off</sub>    | Turn-Off Switching Energy <sup>⑩</sup>                    |  | -   | 0.755 | -   |      |
| t <sub>d(on)</sub>  | Turn-On Delay Time  | Inductive Switching IGBT and Diode:<br><br>T <sub>J</sub> = 125°C, V <sub>CC</sub> = 400V,<br>I <sub>C</sub> = 50A<br>R <sub>G</sub> = 4.7Ω <sup>⑦</sup> , V <sub>GG</sub> = 15V | -   | 33    | -   | ns   |
| t <sub>r</sub>      | Rise Time   |  | -   | 33    | -   |      |
| t <sub>d(off)</sub> | Turn-Off Delay Time                                       |  | -   | 250   | -   |      |
| t <sub>f</sub>      | Fall Time   |  | -   | 23    | -   |      |
| E <sub>on1</sub>    | Turn-On Switching Energy <sup>⑧</sup>                     | Inductive Switching IGBT and Diode:<br><br>T <sub>J</sub> = 125°C, V <sub>CC</sub> = 400V,<br>I <sub>C</sub> = 50A<br>R <sub>G</sub> = 4.7Ω <sup>⑦</sup> , V <sub>GG</sub> = 15V | -   | TBD   | -   | mJ   |
| E <sub>on2</sub>    | Turn-On Switching Energy <sup>⑨</sup>                     |  | -   | 1.7   | -   |      |
| E <sub>off</sub>    | Turn-Off Switching Energy <sup>⑩</sup>                    |  | -   | 0.950 | -   |      |

**TYPICAL PERFORMANCE CURVES**

**APT50GS60BRDL(G)**

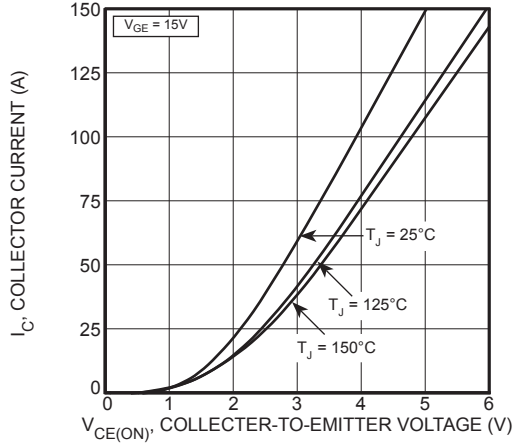

**FIGURE 1, Output Characteristics**

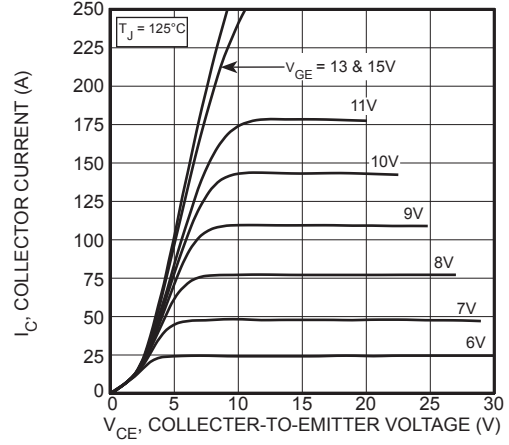

**FIGURE 2, Output Characteristics**

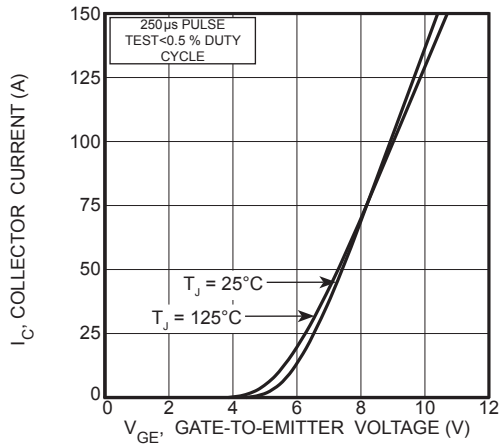

**FIGURE 3, Transfer Characteristics**

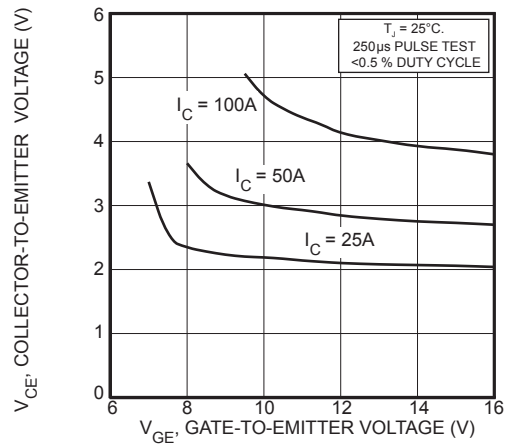

**FIGURE 4, On State Voltage vs Gate-to-Emitter Voltage**

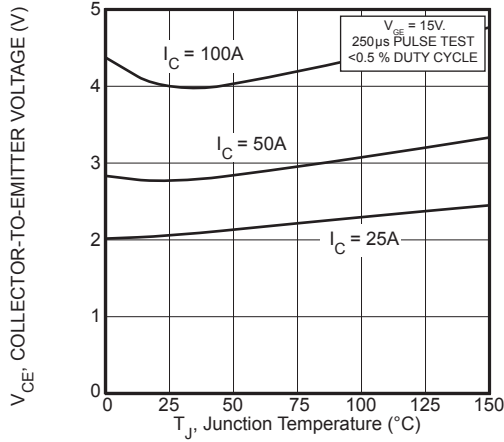

**FIGURE 5, On State Voltage vs Junction Temperature**

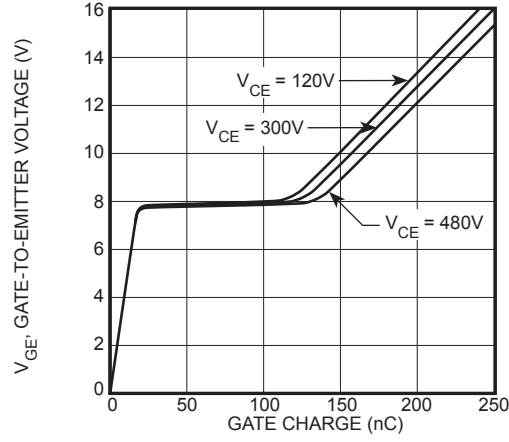

**FIGURE 6, Gate Charge**

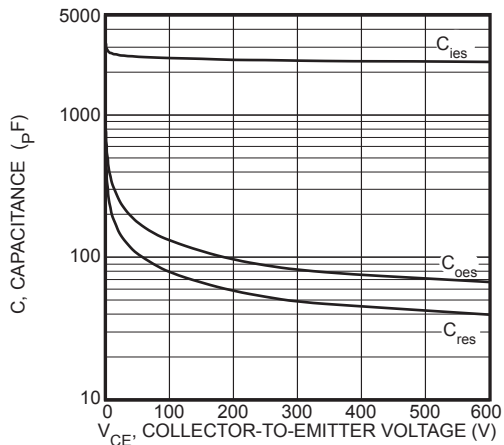

**FIGURE 7, Capacitance vs Collector-To-Emitter Voltage**

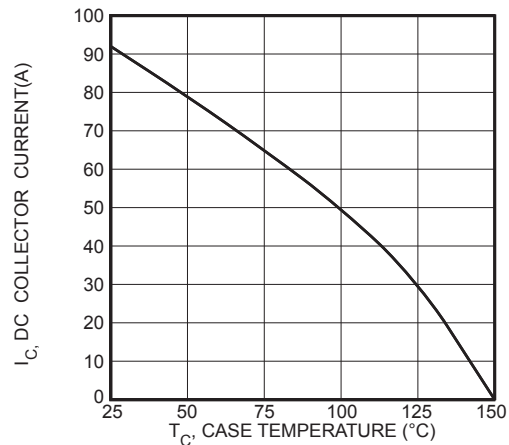

**FIGURE 8, DC Collector Current vs Case Temperature**

**TYPICAL PERFORMANCE CURVES**

**APT50GS60BRDL(G)**

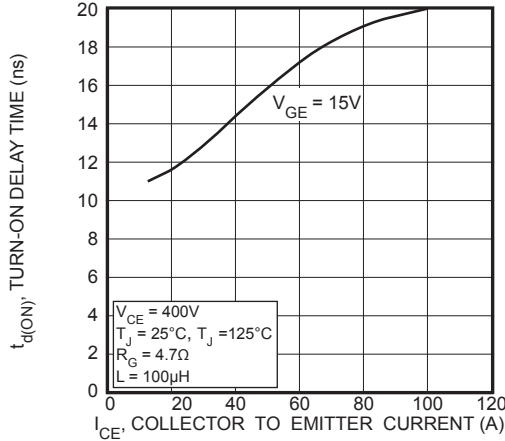

**FIGURE 9, Turn-On Delay Time vs Collector Current**

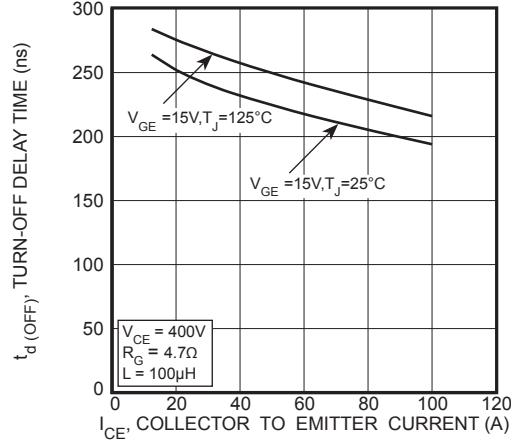

**FIGURE 10, Turn-Off Delay Time vs Collector Current**

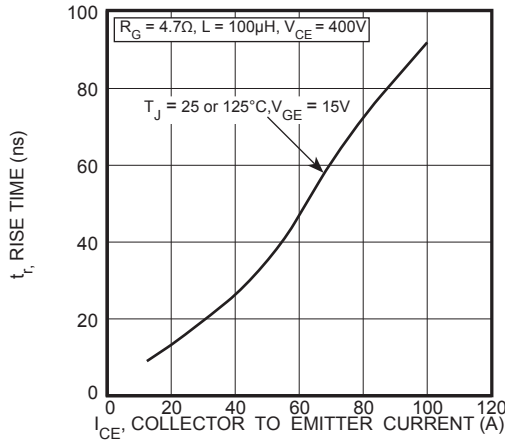

**FIGURE 11, Current Rise Time vs Collector Current**

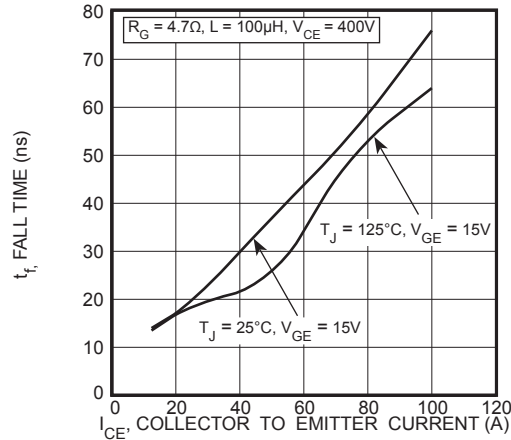

**FIGURE 12, Current Fall Time vs Collector Current**

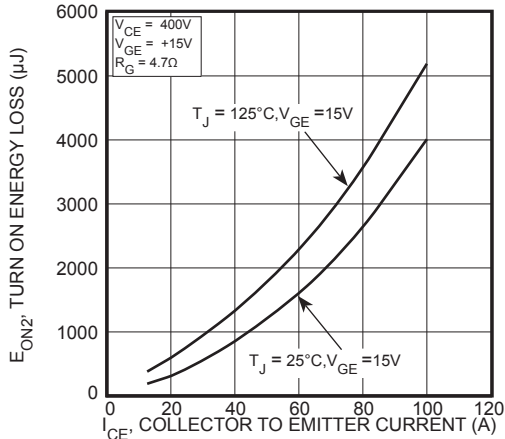

**FIGURE 13, Turn-On Energy Loss vs Collector Current**

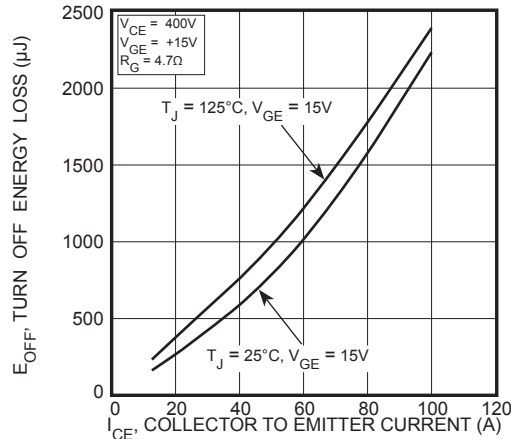

**FIGURE 14, Turn Off Energy Loss vs Collector Current**

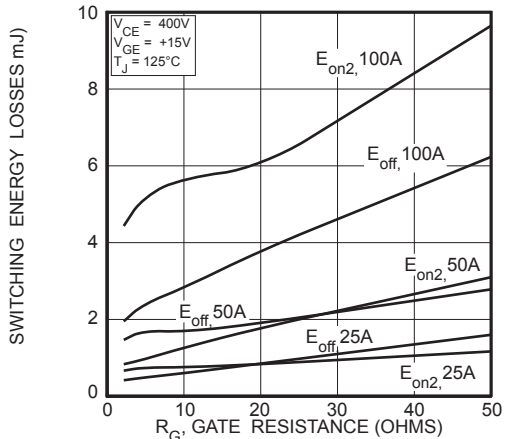

**FIGURE 15, Switching Energy Losses vs. Gate Resistance**

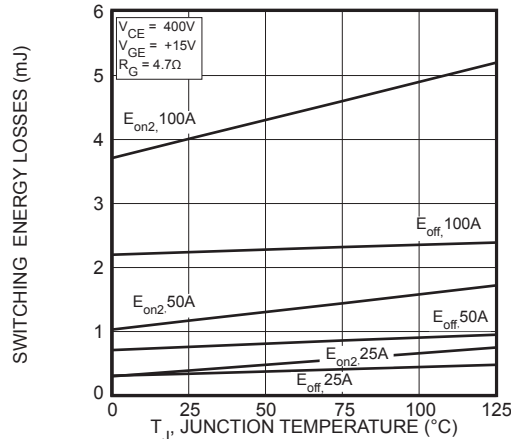

**FIGURE 16, Switching Energy Losses vs Junction Temperature**

# TYPICAL PERFORMANCE CURVES

APT50GS60BRDL(G)

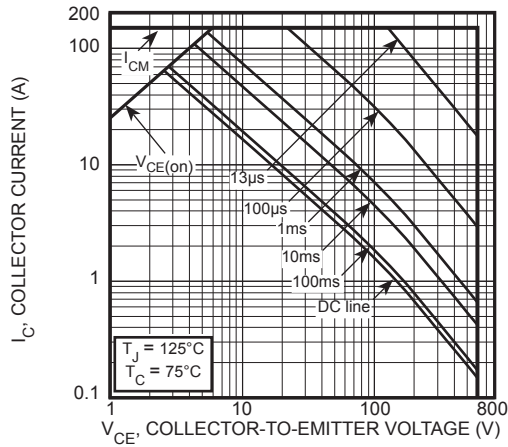

Figure 17, Forward Safe Operating Area

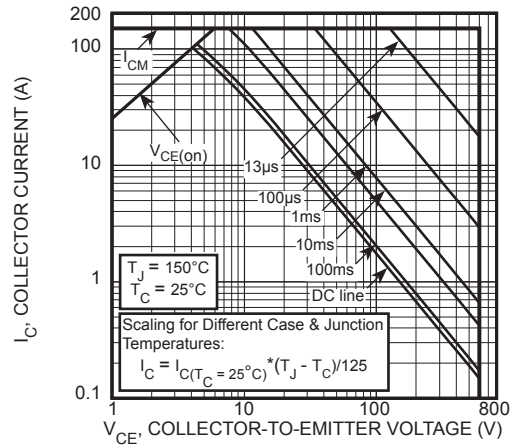

Figure 18, Maximum Forward Safe Operating Area

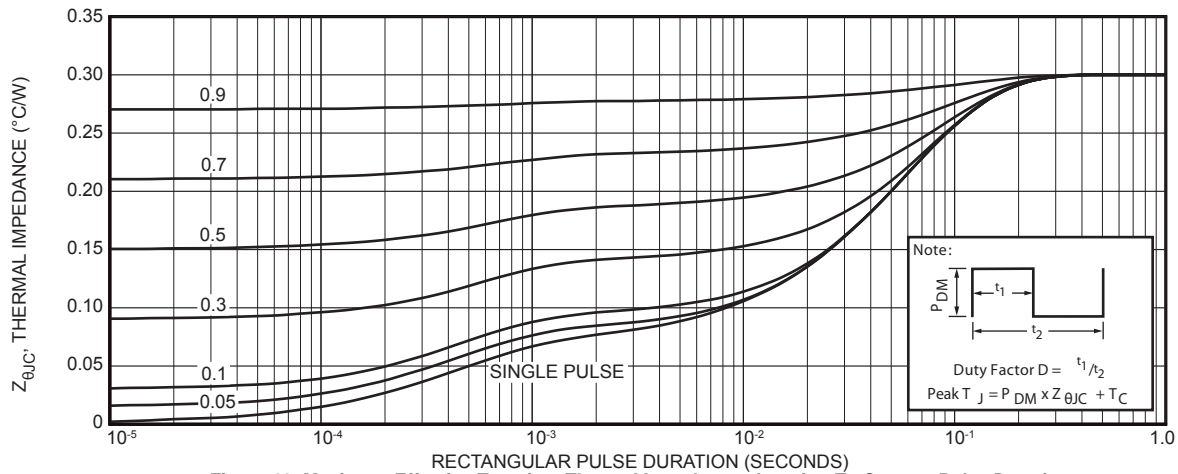

Figure 19, Maximum Effective Transient Thermal Impedance, Junction-To-Case vs Pulse Duration

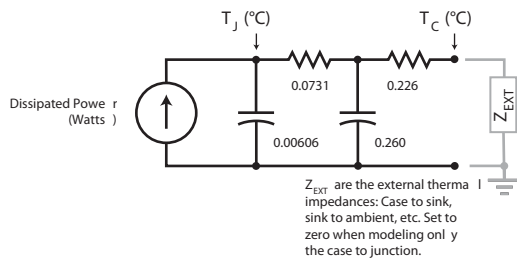

Figure 20, Transient Thermal Impedance Model

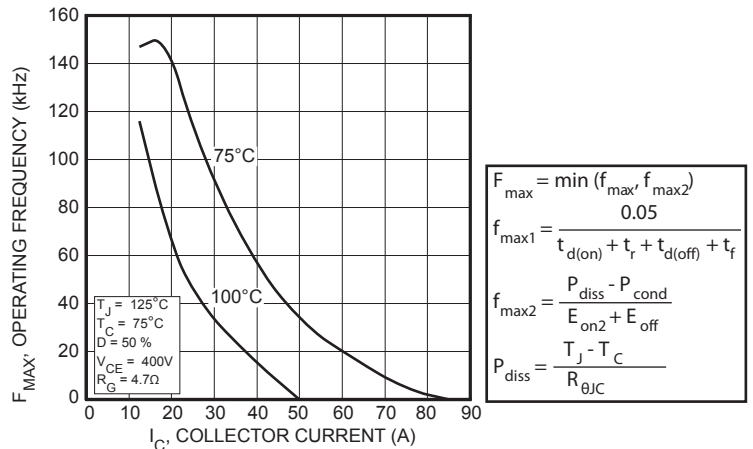

Figure 21, Operating Frequency vs Collector Current

$$F_{max} = \min(f_{max1}, f_{max2})$$

$$f_{max1} = \frac{0.05}{t_{d(on)} + t_r + t_{d(off)} + t_f}$$

$$f_{max2} = \frac{P_{diss} - P_{cond}}{E_{on2} + E_{off}}$$

$$P_{diss} = \frac{T_J - T_C}{R_{\theta JC}}$$

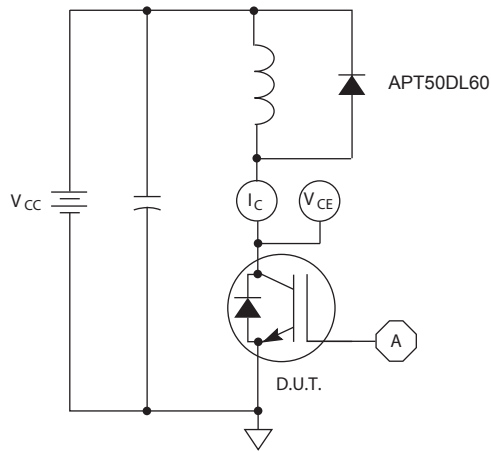

Figure 22, Inductive Switching Test Circuit

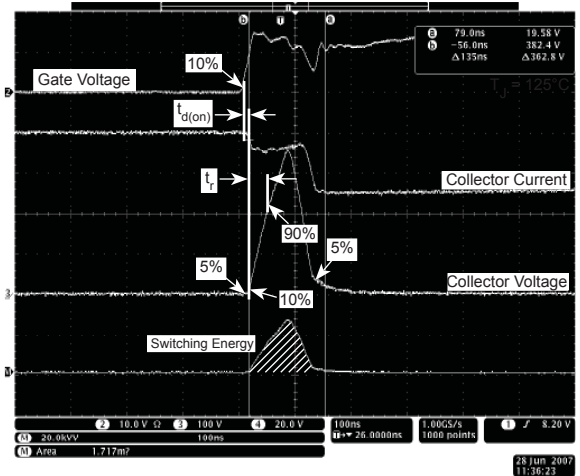

Figure 23, Turn-on Switching Waveforms and Definitions

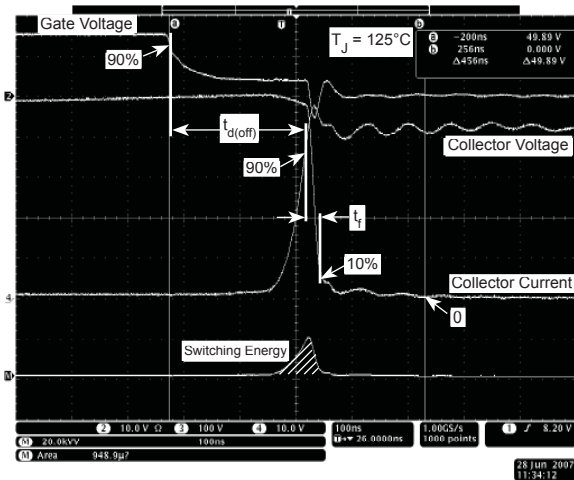

Figure 24, Turn-off Switching Waveforms and Definitions

FOOT NOTE:

- ① Repetitive Rating: Pulse width and case temperature limited by maximum junction temperature.
- ③ Short circuit time:  $V_{GE} = 15V$ ,  $V_{CC} \leq 600V$ ,  $T_J \leq 150^\circ C$
- ④ Pulse test: Pulse width  $< 380\mu s$ , duty cycle  $< 2\%$
- ⑤  $C_{o(cr)}$  is defined as a fixed capacitance with the same stored charge as  $C_{oes}$  with  $V_{CE} = 67\%$  of  $V_{(BR)CES}$ .
- ⑥  $C_{o(er)}$  is defined as a fixed capacitance with the same stored energy as  $C_{oes}$  with  $V_{CE} = 67\%$  of  $V_{(BR)CES}$ . To calculate  $C_{o(er)}$  for any value of  $V_{CE}$  less than  $V_{(BR)CES}$ , use this equation:  $C_{o(er)} = 5.57E-8/V_{DS}^2 + 7.15E-8/V_{DS} + 2.75E-10$ .
- ⑦  $R_G$  is external gate resistance, not including internal gate resistance or gate driver impedance (MIC4452).
- ⑧  $E_{on1}$  is the inductive turn-on energy of the IGBT only, without the effect of a commutating diode reverse recovery current adding to the IGBT turn-on switching loss. It is measured by clamping the inductance with a Silicon Carbide Schottky diode.
- ⑨  $E_{on2}$  is the inductive turn-on energy that includes a commutating diode reverse recovery current in the IGBT turn-on energy.
- ⑩  $E_{off}$  is the clamped inductive turn-off energy measured in accordance with JEDEC standard JESD24-1.

Microsemi reserves the right to change, without notice, the specifications and information contained herein.

# ULTRAFAST SOFT RECOVERY ANTI-PARALLEL DIODE

**MAXIMUM RATINGS**

All Ratings:  $T_C = 25^\circ\text{C}$  unless otherwise specified.

| Symbol     | Characteristic / Test Conditions  | APT50GS60BRDL(G) |  | UNIT |
|------------|---|------------------|--|------|
| $I_F(AV)$  | Maximum Average Forward Current ( $T_C = 124^\circ\text{C}$ , Duty Cycle = 0.5) | 50               |  | Amps |
| $I_F(RMS)$ | RMS Forward Current (Square wave, 50% duty)                                     | 150              |  |      |
| $I_{FSM}$  | Non-Repetitive Forward Surge Current ( $T_J = 45^\circ\text{C}$ , 8.3ms)        | 320              |  |      |

**STATIC ELECTRICAL CHARACTERISTICS**

| Symbol | Characteristic / Test Conditions | MIN   | TYP  | MAX | UNIT  |
|--------|----------------------------------|---|------|-----|-------|
| $V_F$  | Forward Voltage                  | $I_F = 50\text{A}$                          | 1.25 | 1.6 | Volts |
|        |                                  | $I_F = 100\text{A}$                         | 2.0  |     |       |
|        |                                  | $I_F = 50\text{A}, T_J = 125^\circ\text{C}$ | 1.25 |     |       |

**DYNAMIC CHARACTERISTICS**

| Symbol    | Characteristic                   | Test Conditions   | MIN | TYP  | MAX | UNIT |
|-----------|----------------------------------|---|-----|------|-----|------|
| $t_{rr}$  | Reverse Recovery Time            | $I_F = 1\text{A}, di_F/dt = -100\text{A}/\mu\text{s}, V_R = 30\text{V}, T_J = 25^\circ\text{C}$     | -   | 52   |     | ns   |
| $t_{rr}$  | Reverse Recovery Time            | $I_F = 50\text{A}, di_F/dt = -200\text{A}/\mu\text{s}, V_R = 400\text{V}, T_C = 25^\circ\text{C}$   | -   | 399  |     |      |
| $Q_{rr}$  | Reverse Recovery Charge          |   | -   | 1498 |     | nC   |
| $I_{RRM}$ | Maximum Reverse Recovery Current |   | -   | 9    | -   | Amps |
| $t_{rr}$  | Reverse Recovery Time            | $I_F = 50\text{A}, di_F/dt = -200\text{A}/\mu\text{s}, V_R = 400\text{V}, T_C = 125^\circ\text{C}$  | -   | 649  |     | ns   |
| $Q_{rr}$  | Reverse Recovery Charge          |   | -   | 3734 |     | nC   |
| $I_{RRM}$ | Maximum Reverse Recovery Current |   | -   | 13   | -   | Amps |
| $t_{rr}$  | Reverse Recovery Time            | $I_F = 50\text{A}, di_F/dt = -1000\text{A}/\mu\text{s}, V_R = 400\text{V}, T_C = 125^\circ\text{C}$ | -   | 284  |     | ns   |
| $Q_{rr}$  | Reverse Recovery Charge          |   | -   | 5134 |     | nC   |
| $I_{RRM}$ | Maximum Reverse Recovery Current |   | -   | 34   |     | Amps |

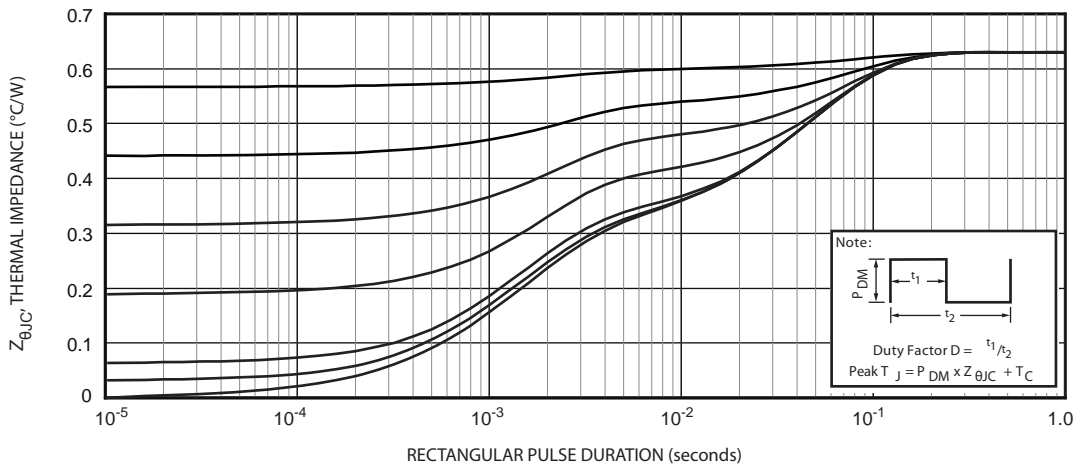

FIGURE 1a. MAXIMUM EFFECTIVE TRANSIENT THERMAL IMPEDANCE, JUNCTION-TO-CASE vs. PULSE DURATION

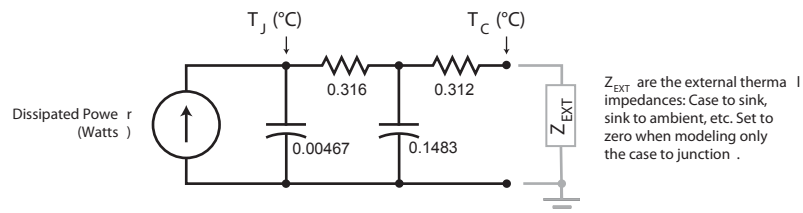

FIGURE 1b. TRANSIENT THERMAL IMPEDANCE MODEL

# TYPICAL PERFORMANCE CURVES

APT50GS60BRDL(G)

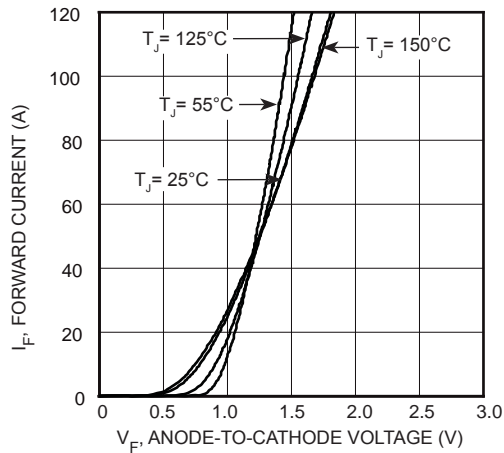

FIGURE 2, Forward Current vs. Forward Voltage

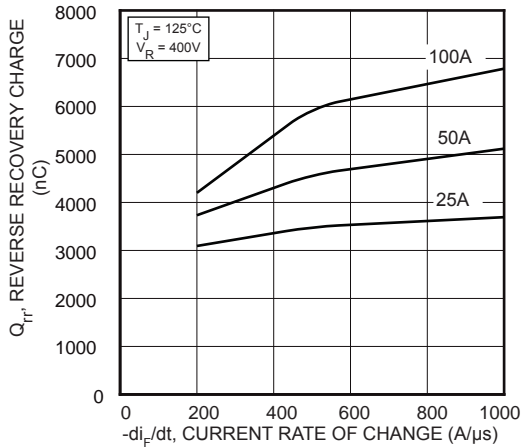

FIGURE 4, Reverse Recovery Charge vs. Current Rate of Change

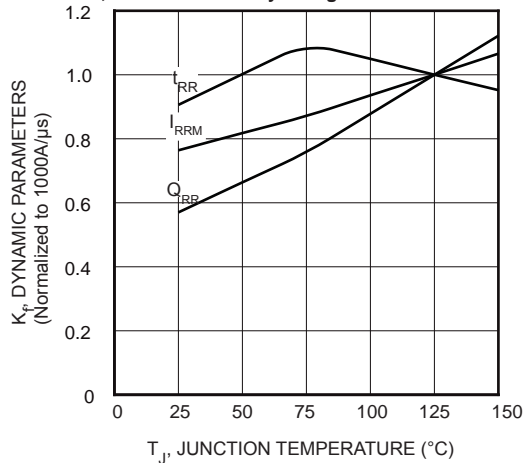

FIGURE 6, Dynamic Parameters vs. Junction Temperature

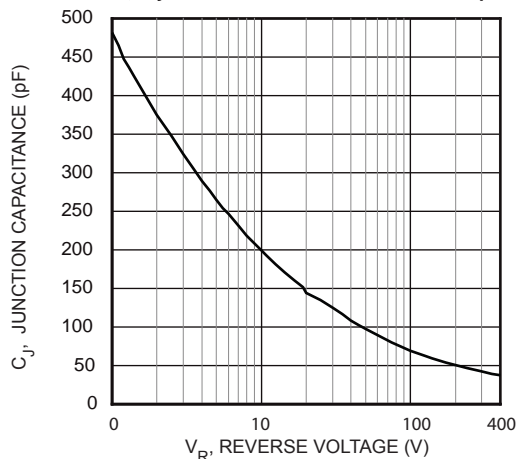

FIGURE 8, Junction Capacitance vs. Reverse Voltage

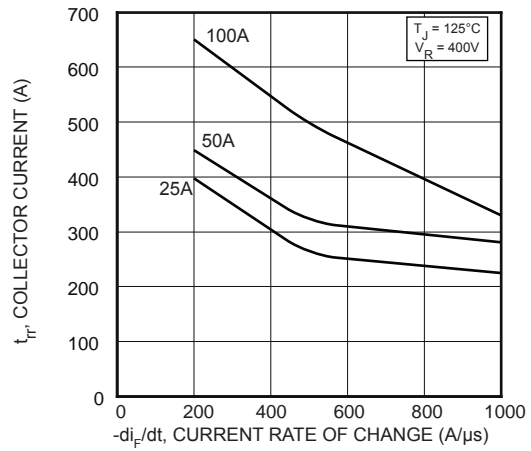

FIGURE 3, Reverse Recovery Time vs. Current Rate of Change

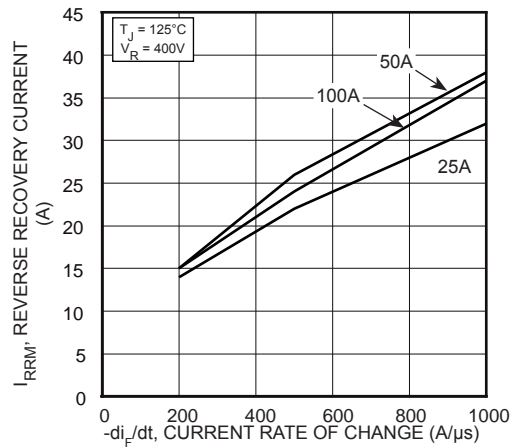

FIGURE 5, Reverse Recovery Current vs. Current Rate of Change

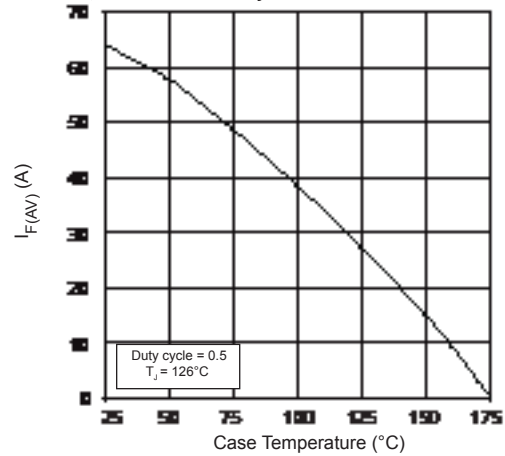

FIGURE 7, Maximum Average Forward Current vs. Case Temperature



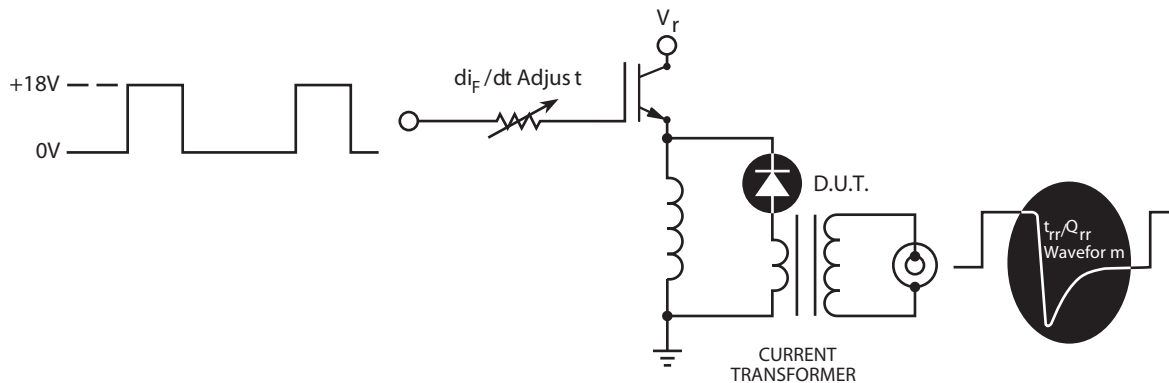

Figure 9. Diode Test Circuit

- 1  $I_F$  - Forward Conduction Current
- 2  $di_F/dt$  - Rate of Diode Current Change Through Zero Crossing.
- 3  $I_{RRM}$  - Maximum Reverse Recovery Current
- 4  $t_{rr}$  - Reverse Recovery Time, measured from zero crossing where the diode current goes from positive to negative, to the point at which the straight line through  $I_{RRM}$  and  $0.25 I_{RRM}$  passes through zero.
- 5  $Q_{rr}$  - Area Under the Curve Defined by  $I_{RRM}$  and  $t_{rr}$ .
- 6  $di_M/dt$  - Maximum Rate of Current Increase During the Trailing Portion of  $t_{rr}$ .

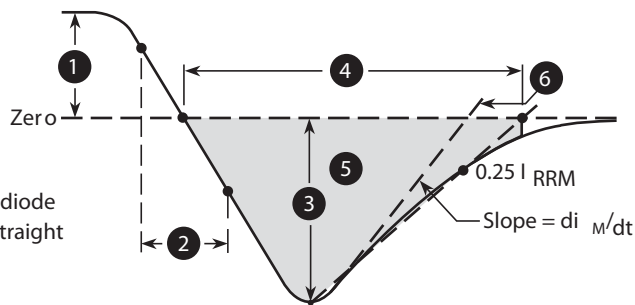
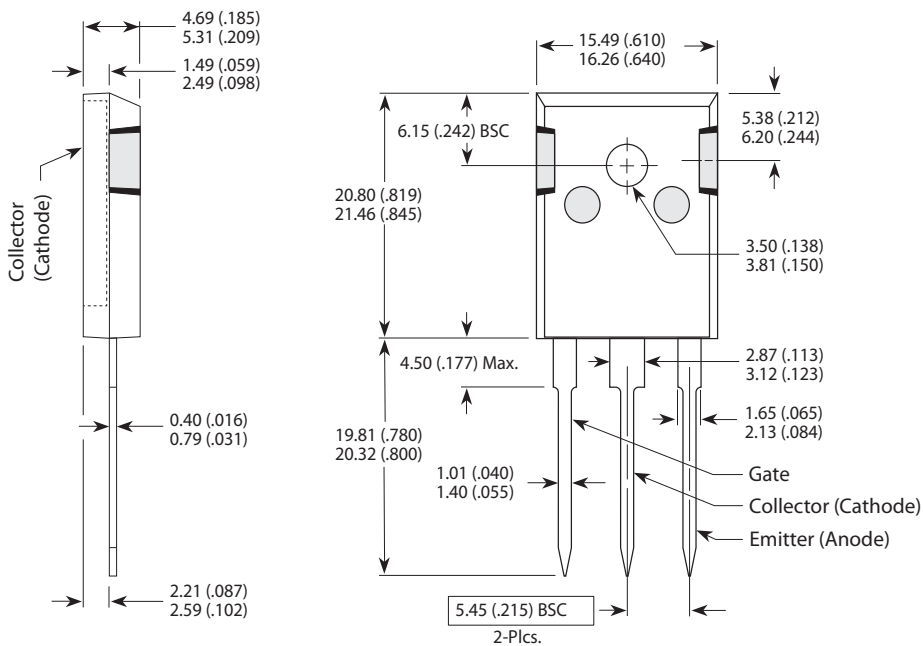

Figure 10, Diode Reverse Recovery Waveform and Definition

### TO-247 (B) Package Outline



Dimensions in Millimeters and (Inches)