

SA58641

High performance mixer FM IF system with high-speed RSSI

Rev. 2 — 9 March 2012

Product data sheet

1. General description

The SA58641 is a high performance monolithic FM IF system with high-speed RSSI incorporating a mixer/oscillator, two limiting intermediate frequency amplifiers, quadrature detector, logarithmic Received Signal Strength Indicator (RSSI), voltage regulator, wideband data output and fast RSSI op amps. The SA58641 is available in 20-lead SSOP (Shrink Small Outline Package).

The SA58641 was designed for high bandwidth portable communication applications and will function down to 3 V. The RF section is similar to the famous SA605. The data output has a minimum bandwidth of 600 kHz. This is designed to demodulate wideband data. The RSSI output is amplified. The RSSI output has access to the feedback pin. This enables the designer to adjust the level of the outputs or add filtering.

SA58641 incorporates a power-down mode which powers down the device when pin 8 (POWER_DOWN_CTRL) is LOW. Power-down logic levels are CMOS and TTL compatible with high input impedance.

2. Features and benefits

- Wideband data output (600 kHz minimum)
- Fast RSSI rise and fall times
- Low power consumption: 7.5 mA typical at 5 V
- Mixer input to >500 MHz
- Mixer noise figure of 12 dB at 240 MHz
- Crystal oscillator effective to 150 MHz (LC oscillator to 1 GHz local oscillator can be injected)
- 92 dB of IF amp/limiter gain
- 25 MHz limiter small signal bandwidth
- Temperature compensated logarithmic RSSI with a dynamic range in excess of 90 dB
- RSSI output internal op amp
- Internal op amps with rail-to-rail outputs
- Low external component count; suitable for crystal/ceramic/LC filters
- Excellent sensitivity: 0.54 μ V into 50 Ω matching network for 12 dB SINAD (Signal-to-Noise-And-Distortion ratio) for 1 kHz tone with RF at 240 MHz and IF at 10.7 MHz
- ESD hardened
- 10.7 MHz filter matching (330 Ω)
- Power-down mode ($I_{CC} = 200 \mu$ A)



3. Applications

- DECT (Digital European Cordless Telephone)
- Digital cordless telephones
- Digital cellular telephones
- Portable high performance communications receivers
- Single conversion VHF/UHF receivers
- FSK and ASK data receivers
- Wireless LANs

4. Ordering information

Table 1. Ordering information

$T_{amb} = -40\text{ }^{\circ}\text{C to } +85\text{ }^{\circ}\text{C}$

Type number	Topside mark	Package		
		Name	Description	Version
SA58641DK	SA58641	SSOP20	plastic shrink small outline package; 20 leads; body width 4.4 mm	SOT266-1

5. Block diagram

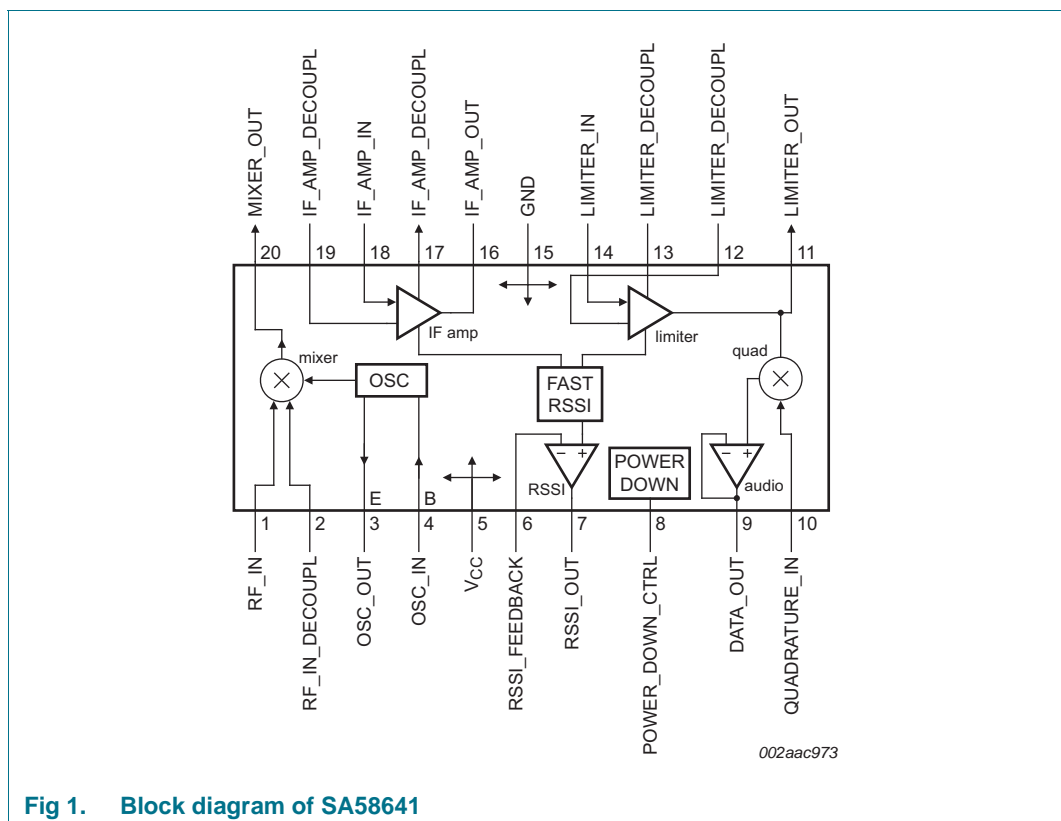

Fig 1. Block diagram of SA58641

6. Pinning information

6.1 Pinning

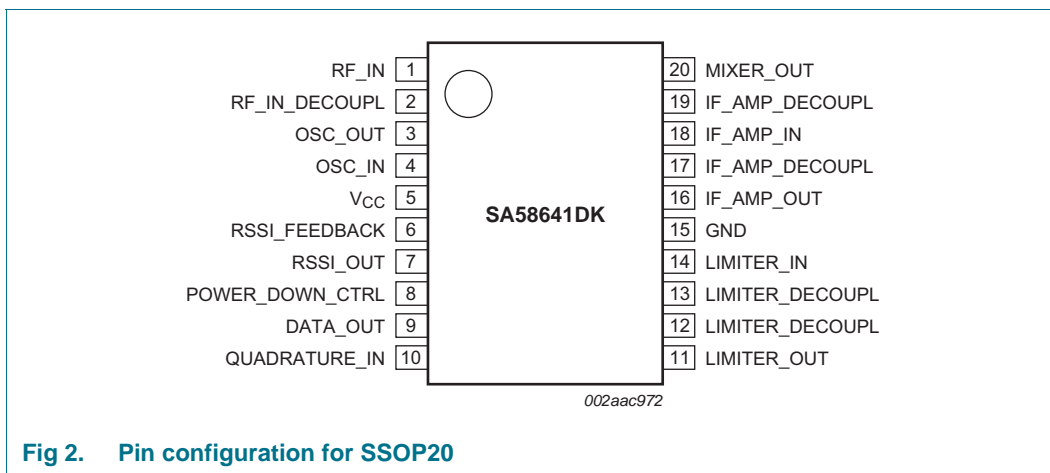

Fig 2. Pin configuration for SSOP20

6.2 Pin description

Table 2. Pin description

Symbol	Pin	Description
RF_IN	1	RF input
RF_IN_DECOUPL	2	RF input decoupling pin
OSC_OUT	3	oscillator output (emitter)
OSC_IN	4	oscillator input (base)
V _{CC}	5	positive supply voltage
RSSI_FEEDBACK	6	RSSI amplifier negative feedback terminal
RSSI_OUT	7	RSSI output
POWER_DOWN_CTRL	8	power-down control, active HIGH
DATA_OUT	9	data output
QUADRATURE_IN	10	quadrature detector input terminal
LIMITER_OUT	11	limiter amplifier output
LIMITER_DECOUPL	12	limiter amplifier decoupling pin
LIMITER_DECOUPL	13	limiter amplifier decoupling pin
LIMITER_IN	14	limiter amplifier input
GND	15	ground; negative supply
IF_AMP_OUT	16	IF amplifier output
IF_AMP_DECOUPL	17	IF amplifier decoupling pin
IF_AMP_IN	18	IF amplifier input
IF_AMP_DECOUPL	19	IF amplifier decoupling pin
MIXER_OUT	20	mixer output

7. Functional description

The SA58641 is an IF signal processing system suitable for second IF or single conversion systems with input frequency as high as 1 GHz. The bandwidth of the IF amplifier is about 40 MHz with 38 dB of gain from a 50 Ω source. The bandwidth of the limiter is about 28 MHz with about 54 dB of gain from a 50 Ω source. However, the gain/bandwidth distribution is optimized for 10.7 MHz, 330 Ω source applications. The overall system is well-suited to battery operation as well as high performance and high quality products of all types such as cordless and cellular hand-held phones.

The input stage is a Gilbert cell mixer with oscillator. Typical mixer characteristics include a noise figure of 14 dB, conversion gain of 11 dB, and input third-order intercept of -16 dBm. The oscillator will operate in excess of 1 GHz in L/C tank configurations. Hartley or Colpitts circuits can be used up to 100 MHz for crystal configurations. Butler oscillators are recommended for crystal configurations up to 150 MHz.

The output of the mixer is internally loaded with a 330 Ω resistor permitting direct connection to a 10.7 MHz ceramic filter for narrowband applications. The input resistance of the limiting IF amplifiers is also 330 Ω . With most 10.7 MHz ceramic filters and many crystal filters, no impedance matching network is necessary. For applications requiring wideband IF filtering, such as DECT, external LC filters are used (see [Figure 16](#)). To achieve optimum linearity of the log signal strength indicator, there must be a 6 dBV insertion loss between the first and second IF stages. If the IF filter or interstage network does not cause 6 dBV insertion loss, a fixed or variable resistor can be added between the first IF output (IF_AMP_OUT) and the interstage network.

The signal from the second limiting amplifier goes to a Gilbert cell quadrature detector. One port of the Gilbert cell is internally driven by the IF. The other output of the IF is AC-coupled to a tuned quadrature network. This signal, which now has a 90° phase relationship to the internal signal, drives the other port of the multiplier cell.

Overall, the IF section has a gain of 90 dB for operation at intermediate frequency at 10.7 MHz. Special care must be given to layout, termination, and interstage loss to avoid instability.

The demodulated output (DATA_OUT) of the quadrature is a voltage output. This output is designed to handle a minimum bandwidth of 600 kHz. This is designed to demodulate wideband data, such as in DECT applications.

A Received Signal Strength Indicator (RSSI) completes the circuitry. The output range is greater than 90 dB and is temperature compensated. This log signal strength indicator exceeds the criteria for AMPS or TACS cellular telephone, DECT and RCR-28 cordless telephone. This signal drives an internal op amp. The op amp is capable of rail-to-rail output. It can be used for gain, filtering, or second-order temperature compensation of the RSSI, if needed.

Remark: $\text{dBV} = 20\log V_O/V_I$.

8. Internal circuitry

Table 3. Internal circuits for each pin

Symbol	Pin	DC Voltage	Equivalent circuit
RF_IN RF_IN_DECOUPL	1 2	+1.07 V +1.07 V	
OSC_OUT OSC_IN	3 4	+1.57 V +2.32 V	
V _{CC}	5	+3.00 V	
RSSI_FEEDBACK	6	+0.20 V	

Table 3. Internal circuits for each pin ...continued

Symbol	Pin	DC Voltage	Equivalent circuit
RSSI_OUT	7	+0.20 V	<p>002aac988</p>
POWER_DOWN_CTRL	8	+2.75 V	<p>002aac989</p>
DATA_OUT	9	+1.09 V	<p>002aac990</p>
QUADRATURE_IN	10	+3.00 V	<p>002aac991</p>
LIMITER_OUT	11	+1.35 V	<p>002aac992</p>

Table 3. Internal circuits for each pin ...continued

Symbol	Pin	DC Voltage	Equivalent circuit
LIMITER_DECOUPL	12	+1.23 V	<p>002aac993</p>
LIMITER_DECOUPL	13	+1.23 V	
LIMITER_IN	14	+1.23 V	
GND	15	0 V	-
IF_AMP_OUT	16	+1.22 V	<p>002aac994</p>
IF_AMP_DECOUPL	17	+1.22 V	<p>002aac995</p>
IF_AMP_IN	18	+1.22 V	
IF_AMP_DECOUPL	19	+1.22 V	
MIXER_OUT	20	+1.03 V	<p>002aac996</p>

9. Limiting values

Table 4. Limiting values

In accordance with the Absolute Maximum Rating System (IEC 60134).

Symbol	Parameter	Conditions	Min	Max	Unit
V_{CC}	supply voltage		0.3	7	V
V_n	voltage on any other pin	except GND	-0.3	$V_{CC} + 0.3$	V
T_{stg}	storage temperature		-65	+150	°C
T_{amb}	ambient temperature	operating	-40	+85	°C

10. Thermal characteristics

Table 5. Thermal characteristics

Symbol	Parameter	Conditions	Max	Unit
$Z_{th(j-a)}$	transient thermal impedance from junction to ambient	SA58641DK (SSOP20)	117	°C/W

11. Static characteristics

Table 6. Static characteristics

$V_{CC} = +5\text{ V}$; $T_{amb} = 25\text{ °C}$; unless otherwise specified.

Symbol	Parameter	Conditions	Min	Typ	Max	Unit
V_{CC}	supply voltage		3	5.0	5.5	V
I_{CC}	supply current	POWER_DOWN_CTRL = HIGH	5.5	7.5	8.5	mA
I_I	input current	POWER_DOWN_CTRL = LOW	-10	-	+10	μA
		POWER_DOWN_CTRL = HIGH	-10	-	+10	μA
V_{IL}	LOW-level input voltage	POWER_DOWN_CTRL = LOW	0	-	$0.3V_{CC}$	V
V_{IH}	HIGH-level input voltage	POWER_DOWN_CTRL = HIGH	$0.7V_{CC}$	-	V_{CC}	V
$I_{CC(stb)}$	standby supply current	POWER_DOWN_CTRL = LOW	-	0.2	0.5	mA
t_{ON}	power-up time	RSSI valid (10 % to 90 %)	-	10	-	μs
t_{OFF}	power-down time	RSSI invalid (90 % to 10 %)	-	5	-	μs

12. Dynamic characteristics

Table 7. Dynamic characteristics

$T_{amb} = 25\text{ }^{\circ}\text{C}$; $V_{CC} = +5\text{ V}$; unless otherwise specified. RF frequency = 240.05 MHz + 14.5 dBV RF input step-up. IF frequency = 10.7 MHz; RF level = -45 dBm; FM modulation = 1 kHz with $\pm 125\text{ kHz}$ peak deviation. Audio output with C-message weighted filter and de-emphasis capacitor. Test circuit [Figure 18](#). The parameters listed are tested using automatic test equipment to assure consistent electrical characteristics. The limits do not represent the ultimate performance limits of the device. Use of an optimized RF layout will improve many of the listed parameters.

Symbol	Parameter	Conditions	Min	Typ	Max	Unit
Mixer/oscillator section (external LO = 160 mV RMS value)						
f_i	input frequency		-	500	-	MHz
f_{osc}	oscillator frequency	external (buffer)	-	500	-	MHz
NF	noise figure	at 240 MHz	-	12	-	dB
IP3 _I	input third-order intercept point	matched f1 = 240.05 MHz; f2 = 240.35 MHz	-	-16	-	dBm
$G_{p(conv)}$	conversion power gain	matched 14.5 dBV step-up	8	11	-	dB
$R_{i(RF)}$	RF input resistance	single-ended input	-	700	-	Ω
$C_{i(RF)}$	RF input capacitance		-	3.5	-	pF
$R_{o(mix)}$	mixer output resistance	MIXER_OUT (pin 20)	-	330	-	Ω
IF section						
$G_{amp(IF)}$	IF amplifier gain	330 Ω load	-	38	-	dB
G_{lim}	limiter gain	330 Ω load	-	54	-	dB
$P_{i(IF)}$	IF input power	for -3 dB input limiting sensitivity; test at IF_AMP_IN (pin 18)	-	-105	-	dBm
α_{AM}	AM rejection	80 % AM 1 kHz	-	50	-	
$V_{o(RMS)}$	RMS output voltage	$R_L = 100\text{ k}\Omega$	120	130	-	mV
B_{3dB}	3 dB bandwidth	data	600	700	-	kHz
SINAD	signal-to-noise-and-distortion ratio	RF level = -111 dBm	-	16	-	dB
THD	total harmonic distortion		-	-43	-38	dB
S/N	signal-to-noise ratio	no modulation for noise	-	60	-	dB
$V_{o(RSSI)}$	RSSI output voltage	IF with buffer				
		IF level = -90 dBm	-	0.6	1.0	V
		IF level = -45 dBm	0.2	1.2	1.8	V
		IF level = -10 dBm	0.8	1.6	2.3	V
$t_{r(o)}$	output rise time	IF RSSI; 10 kHz pulse; no 10.7 MHz filter; no RSSI bypass capacitor; IF frequency = 10.7 MHz				
		RF level = -56 dBm	-	1.2	-	μs
		RF level = -28 dBm	-	1.1	-	μs
$t_{f(o)}$	output fall time	IF RSSI; 10 kHz pulse; no 10.7 MHz filter; no RSSI bypass capacitor; IF frequency = 10.7 MHz				
		RF level = -56 dBm	-	2.0	-	μs
		RF level = -28 dBm	-	7.3	-	μs

Table 7. Dynamic characteristics ...continued

$T_{amb} = 25\text{ }^{\circ}\text{C}$; $V_{CC} = +5\text{ V}$; unless otherwise specified. RF frequency = 240.05 MHz + 14.5 dBV RF input step-up. IF frequency = 10.7 MHz; RF level = -45 dBm; FM modulation = 1 kHz with $\pm 125\text{ kHz}$ peak deviation. Audio output with C-message weighted filter and de-emphasis capacitor. Test circuit [Figure 18](#). The parameters listed are tested using automatic test equipment to assure consistent electrical characteristics. The limits do not represent the ultimate performance limits of the device. Use of an optimized RF layout will improve many of the listed parameters.

Symbol	Parameter	Conditions	Min	Typ	Max	Unit
$\alpha_{RSSI(\text{range})}$	RSSI range		-	70	-	dB
$\Delta\alpha_{RSSI}$	RSSI variation		-	± 2.0	-	dB
$Z_{i(\text{IF})}$	IF input impedance		-	330	-	Ω
$Z_{o(\text{IF})}$	IF output impedance		-	330	-	Ω
$Z_{i(\text{lim})}$	limiter input impedance		-	330	-	Ω
$Z_{o(\text{lim})}$	limiter output impedance		-	330	-	Ω
$V_{o(\text{RMS})}$	RMS output voltage	no load; measured on LIM_OUT pin	-	130	-	mV
RF/IF section (internal LO)						
$V_{o(\text{RSSI})}$	RSSI output voltage	system; RF level = -10 dBm	-	1.4	-	V
SINAD	signal-to-noise-and-distortion ratio	system; RF level = -95 dBm	-	12	-	dB

13. Performance curves

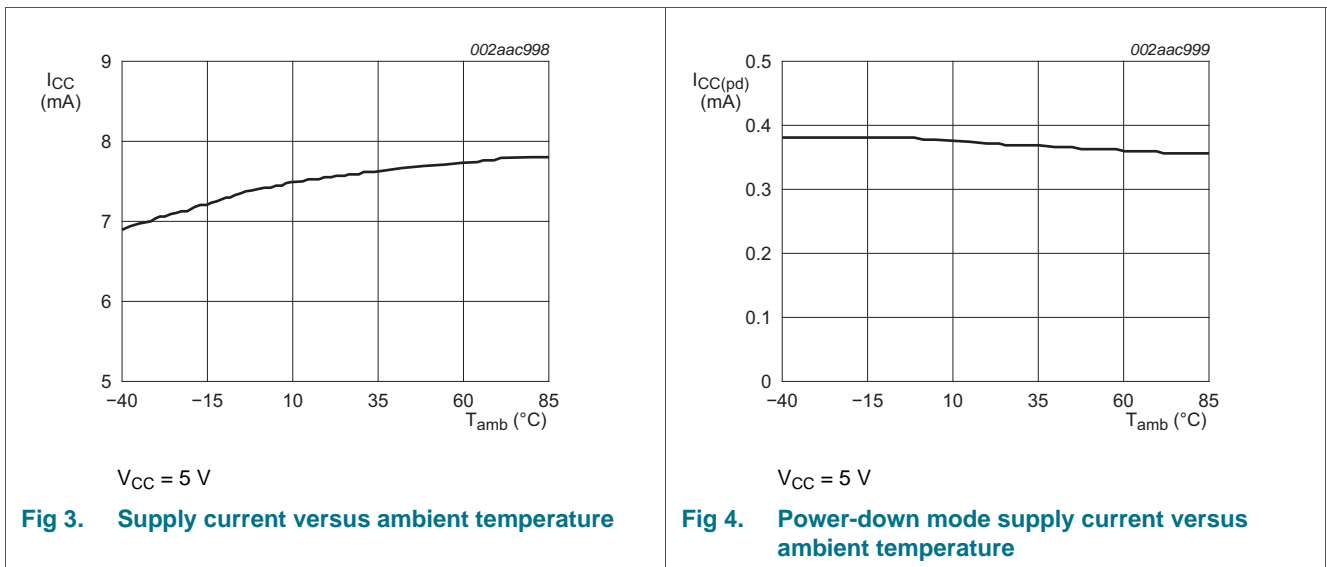

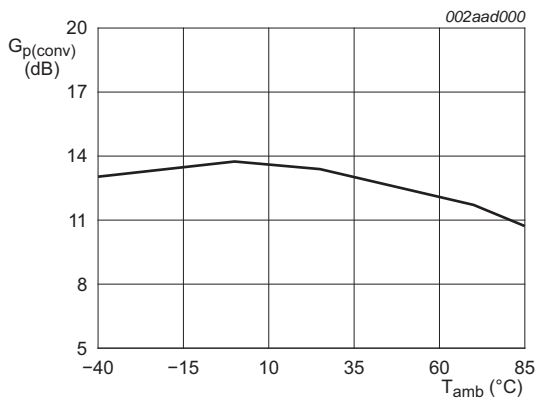

V_{CC} = 5.5 V; RF level = -45 dBm

Fig 5. Mixer conversion power gain versus ambient temperature

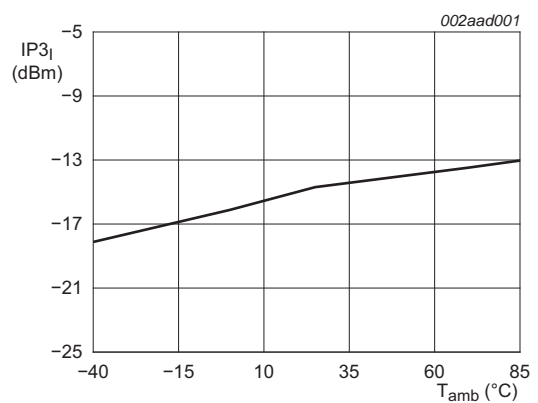

V_{CC} = 5.5 V; RF level = -45 dBm

Fig 6. Mixer input third-order intercept point at 240 MHz versus ambient temperature

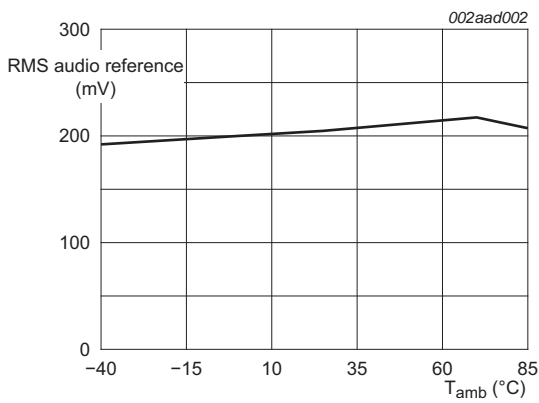

V_{CC} = 5.5 V

Fig 7. Audio reference level versus ambient temperature

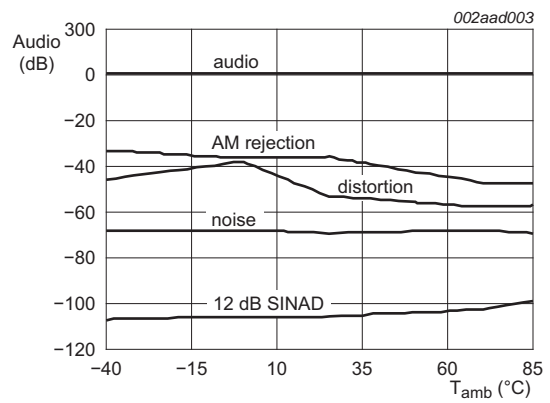

V_{CC} = 5 V; RF = 240 MHz; level = -68 dBm; deviation = 125 kHz

Fig 8. 12 dB SINAD and relative audio, THD, noise and AM rejection versus ambient temperature

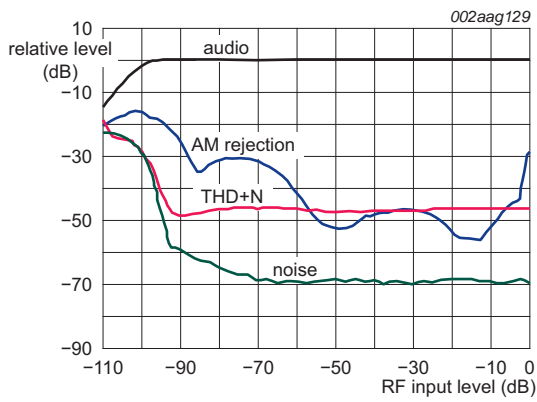

a. $T_{amb} = -40\text{ }^{\circ}\text{C}$; RMS audio level = 118 mV

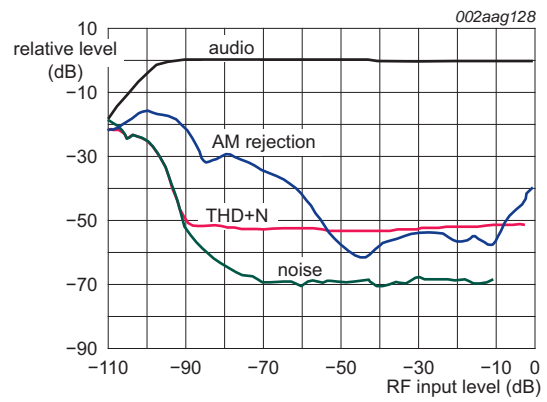

b. $T_{amb} = 25\text{ }^{\circ}\text{C}$; RMS audio level = 129 mV

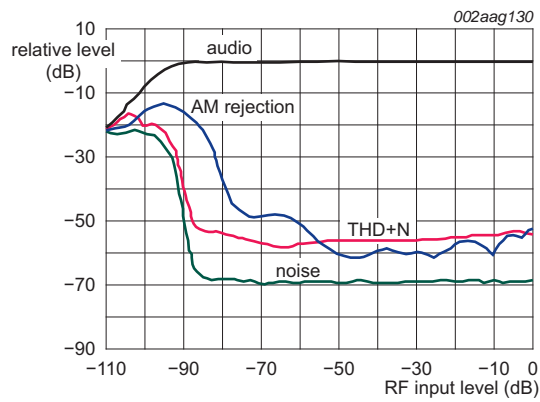

c. $T_{amb} = 85\text{ }^{\circ}\text{C}$; RMS audio level = 131 mV

Fig 9. Receiver RF performance

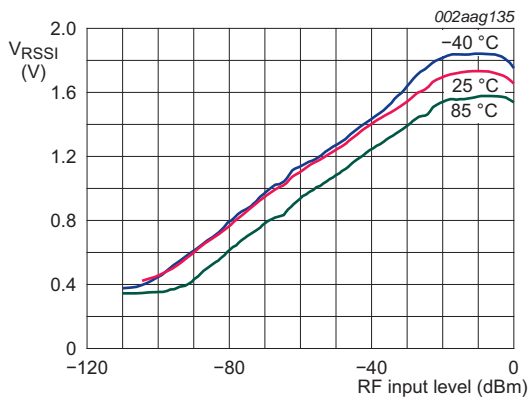

Fig 10. RSSI versus RF input level

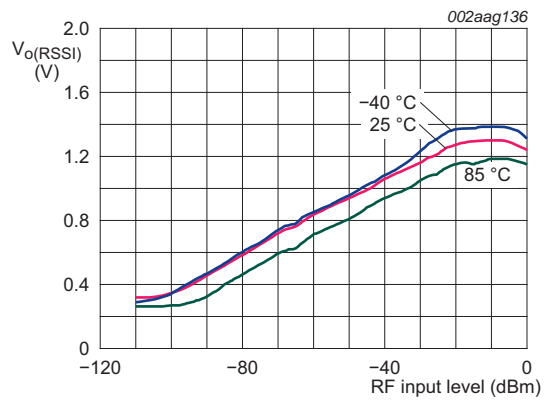

Fig 11. RSSI output versus RF level

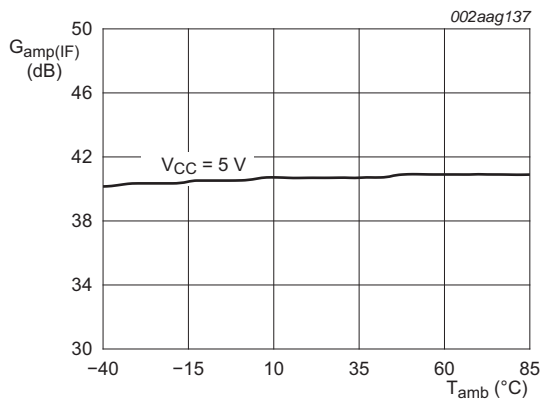

Fig 12. IF amplifier gain versus ambient temperature

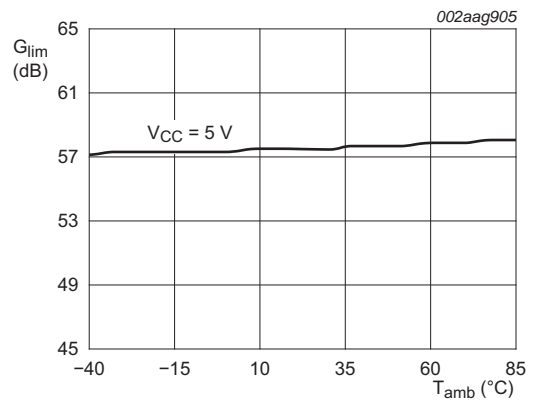

Fig 13. Limiting amplifier gain versus ambient temperature

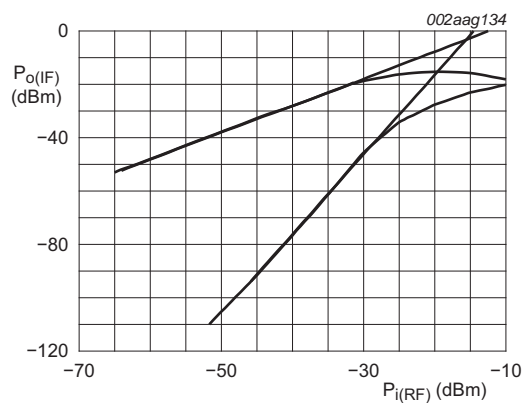
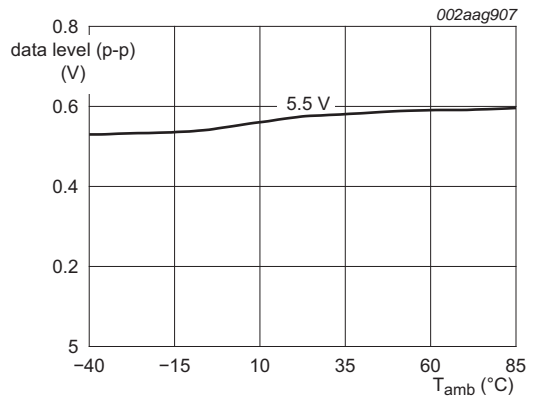
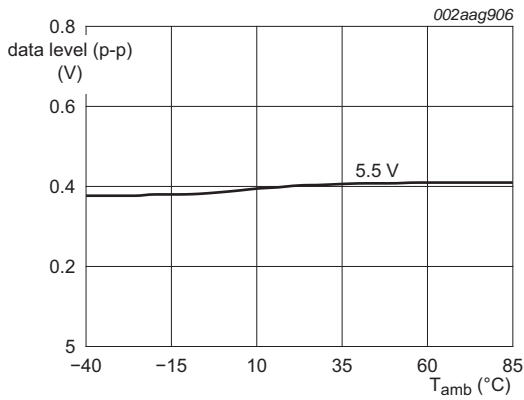

Fig 14. Mixer third-order intercept and compression



a. 600 kHz data rate

IF = 9.85 MHz
 deviation = 288 kHz
 RF = -40 dBm

b. 1 kHz data rate

Fig 15. Data level versus ambient temperature

14. Application information

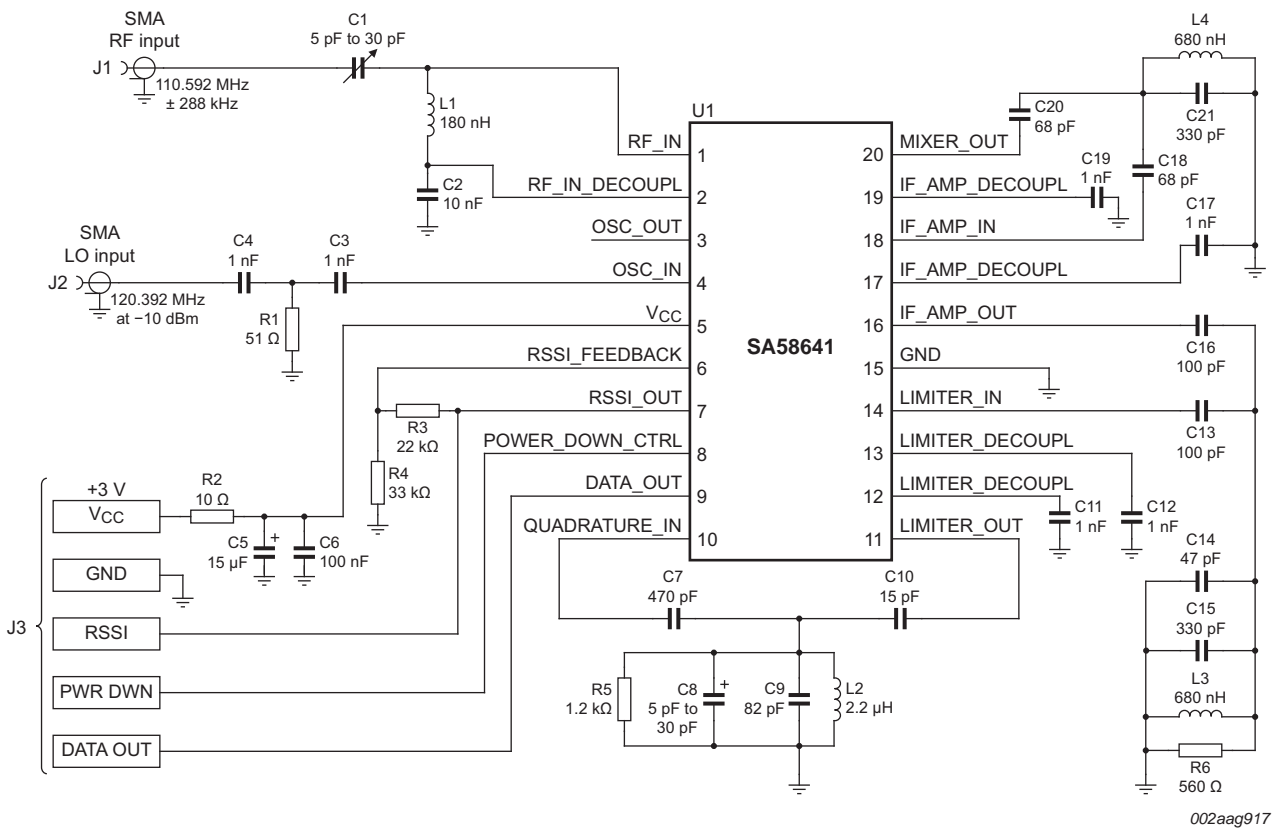

Fig 16. SA58641 110.592 MHz (RF) / 9.8 MHz (IF) DECT application circuit

Table 8. DECT application circuit electrical characteristics

RF frequency = 110.592 MHz; IF frequency = 9.8 MHz; RF level = -45 dBm;

FM modulation = 100 kHz with ± 288 kHz peak deviation.

Symbol	Parameter	Conditions	Typical	Unit
Mixer/oscillator section (external LO = 160 mV RMS value)				
$G_{p(\text{conv})}$	conversion power gain		13	dB
NF	noise figure	at 110 MHz	12	dB
IP3 _i	input third-order intercept point	matched f1 = 110.592 MHz; f2 = 110.892 MHz	-15	dBm
$R_{i(\text{RF})}$	RF input resistance		690	Ω
$C_{i(\text{RF})}$	RF input capacitance		3.6	pF
IF section				
$G_{\text{amp(IF)}}$	IF amplifier gain	330 Ω load	38	dB
G_{lim}	limiter gain	330 Ω load	54	dB
$V_{o(\text{RMS})}$	RMS output voltage	$R_L = 3 \text{ k}\Omega$	130	mV
$B_{3\text{dB}}$	3 dB bandwidth		700	kHz
RF/IF section (internal LO)				
$V_{o(\text{RSSI})}$	RSSI output voltage	system; RF level = -10 dBm	1.4	V
S/N	signal-to-noise ratio ^[1]	system; RF level = -83 dBm	10	dB

[1] 10 dB S/N corresponds to BER = 10^{-3} .

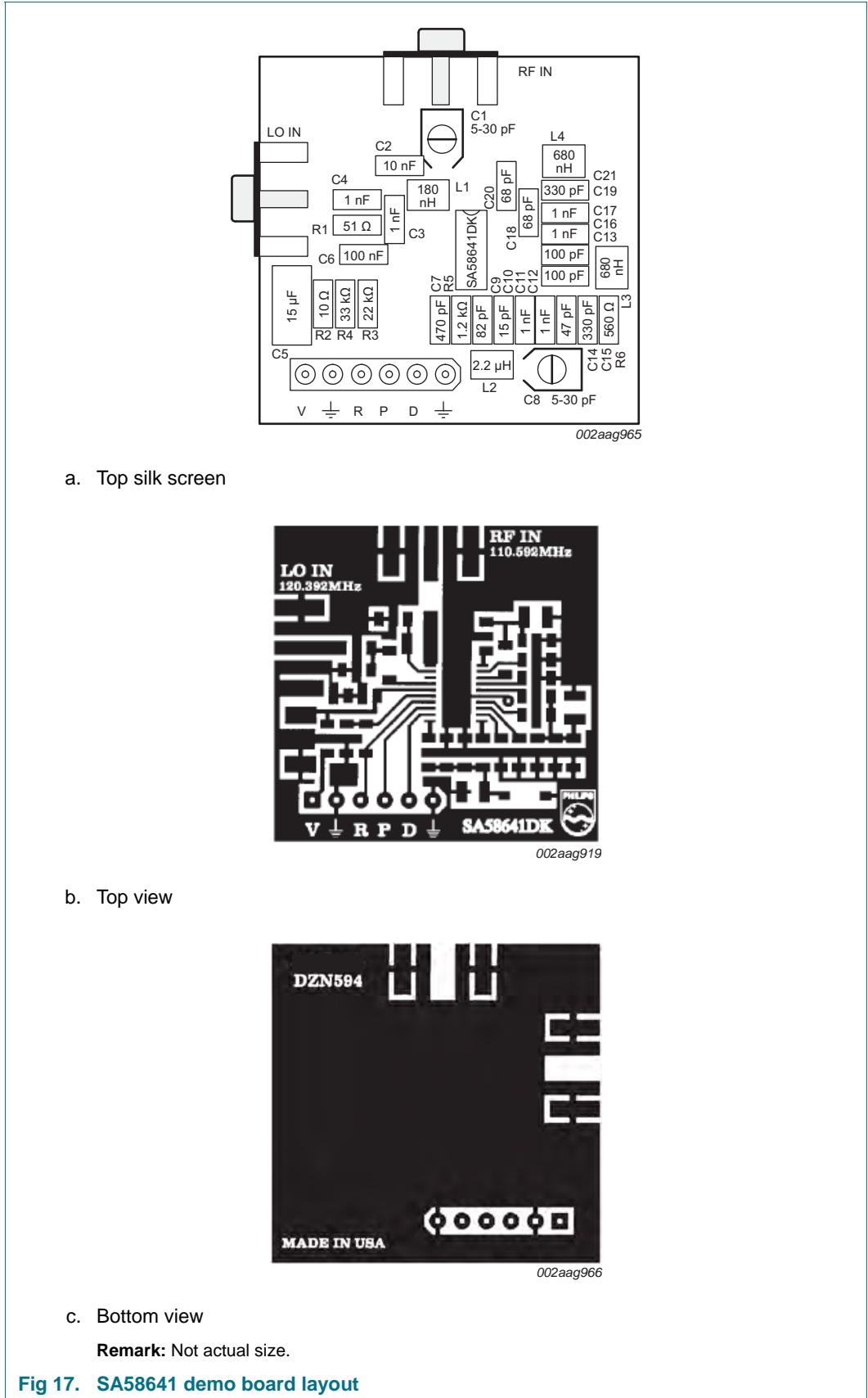

15. Test information

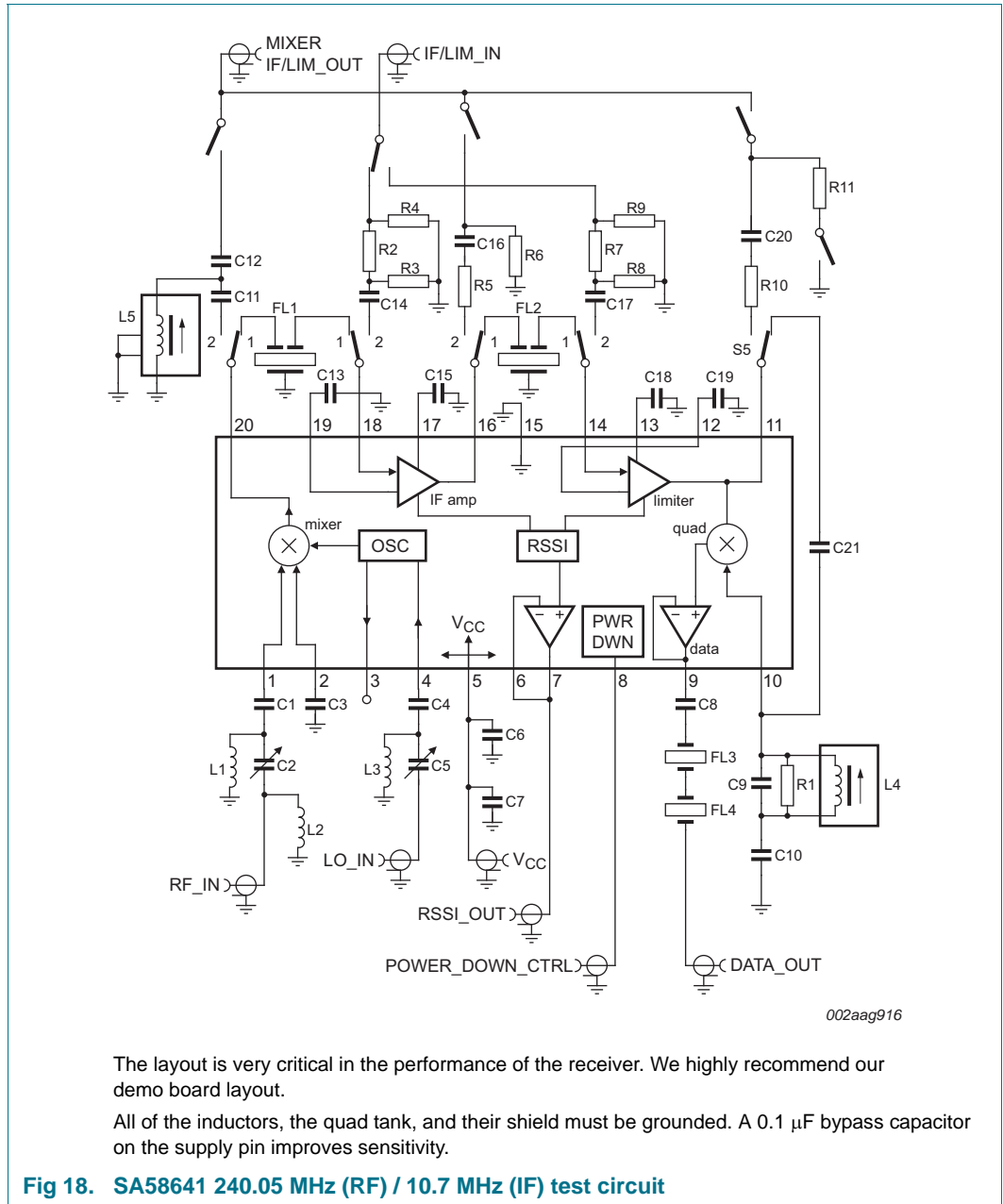
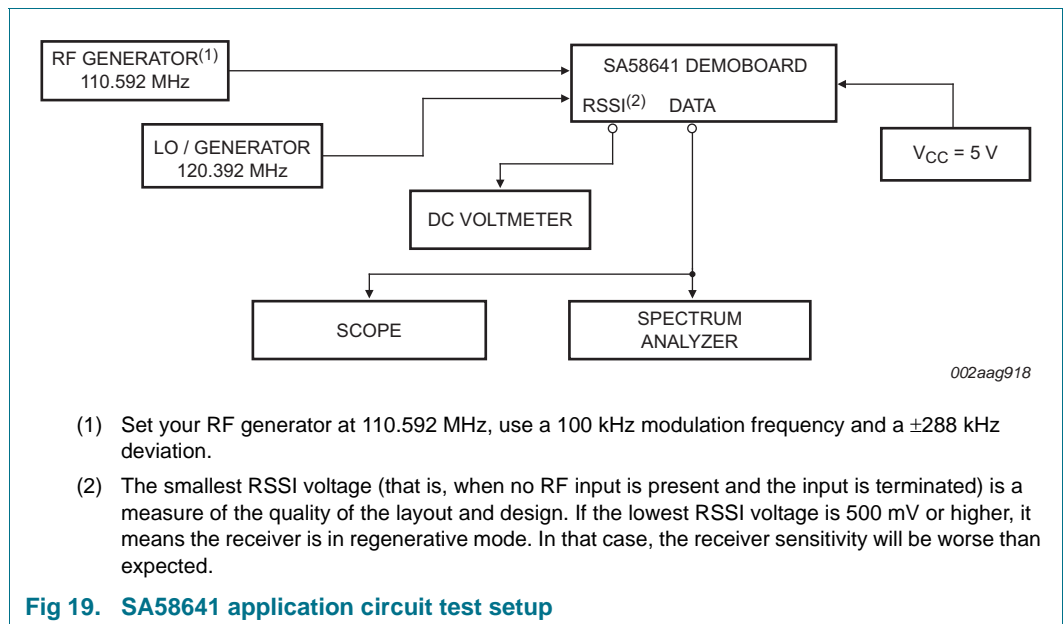

Table 9. Automatic test circuit component list

Component	Description
R1	8.2 kΩ select resistor
R2, R7	6.42 kΩ resistor
R3, R8	347.8 Ω resistor
R4, R6, R9, R11	49.9 Ω resistor
R5, R10	1 kΩ resistor
C1, C3, C4, C10, C11, C14, C16, C17, C20	0.1 μF capacitor
C2, C5	1 pF to 5 pF capacitor, select for input match
C6	100 pF capacitor
C7	6.8 μF, 10 V capacitor ^[1]
C8	1 μF capacitor
C9	39 pF select capacitor
C12	160 pF select capacitor
C13, C15, C18, C19	1000 pF capacitor
C21	1 pF capacitor
L1	150 nH inductor ^[1] , select for input match
L2	22 nH inductor ^[1] , select for input match
L3	47 nH inductor, select for input match
L4	5.6 μH inductor, select for input match
L5	1.27 μH to 2.25 μH inductor, select for mixer output match
FL1, FL2	10.7 MHz filter (Murata SFE10.7MA5-A)
FL3	'C' message weighted filter
FL4	active de-emphasis filter

[1] This value can be reduced when a battery is the power source.



16. Package outline

SSOP20: plastic shrink small outline package; 20 leads; body width 4.4 mm

SOT266-1

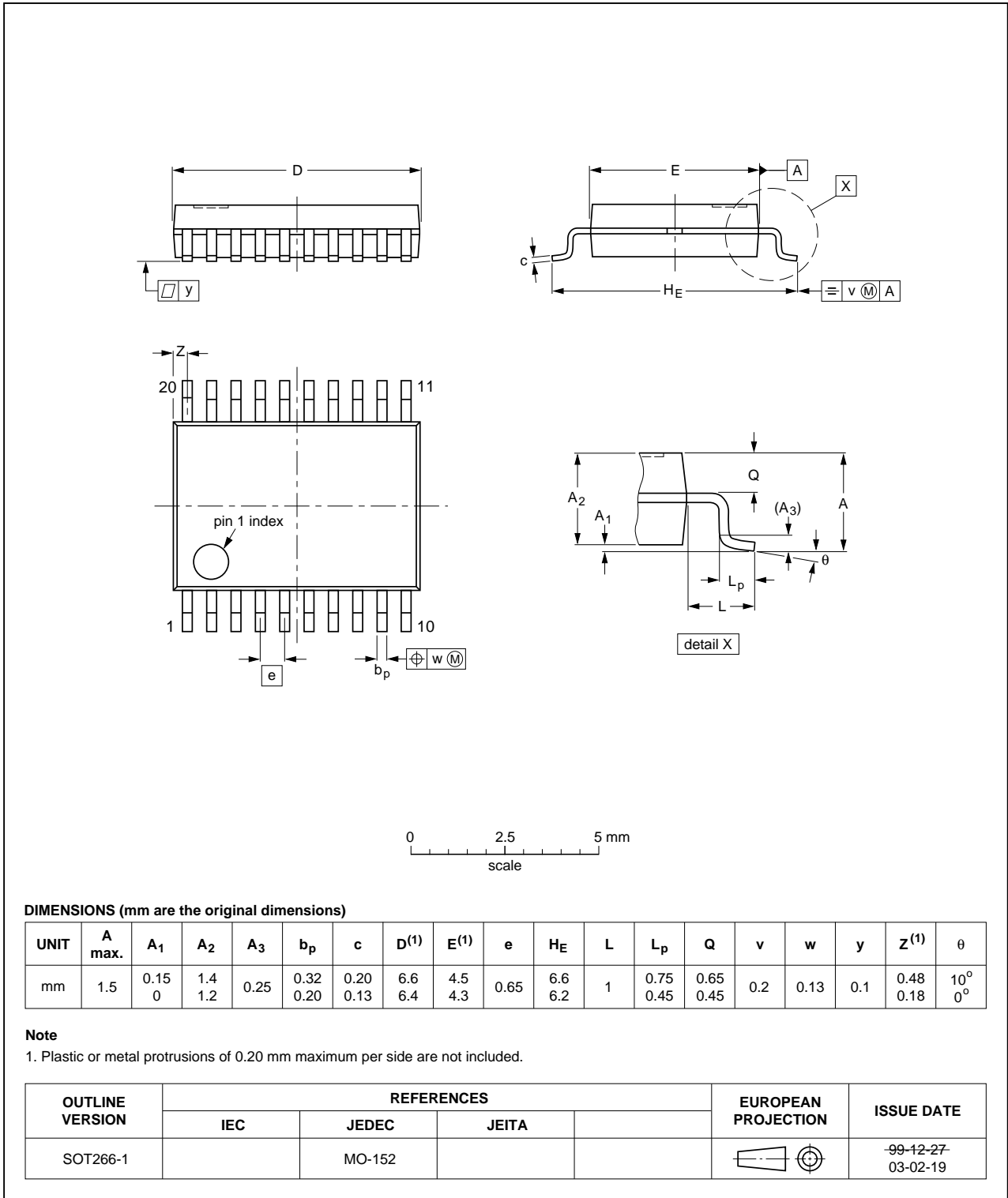

Fig 20. Package outline SOT266-1 (SSOP20)

17. Soldering of SMD packages

This text provides a very brief insight into a complex technology. A more in-depth account of soldering ICs can be found in Application Note *AN10365 "Surface mount reflow soldering description"*.

17.1 Introduction to soldering

Soldering is one of the most common methods through which packages are attached to Printed Circuit Boards (PCBs), to form electrical circuits. The soldered joint provides both the mechanical and the electrical connection. There is no single soldering method that is ideal for all IC packages. Wave soldering is often preferred when through-hole and Surface Mount Devices (SMDs) are mixed on one printed wiring board; however, it is not suitable for fine pitch SMDs. Reflow soldering is ideal for the small pitches and high densities that come with increased miniaturization.

17.2 Wave and reflow soldering

Wave soldering is a joining technology in which the joints are made by solder coming from a standing wave of liquid solder. The wave soldering process is suitable for the following:

- Through-hole components
- Leaded or leadless SMDs, which are glued to the surface of the printed circuit board

Not all SMDs can be wave soldered. Packages with solder balls, and some leadless packages which have solder lands underneath the body, cannot be wave soldered. Also, leaded SMDs with leads having a pitch smaller than ~0.6 mm cannot be wave soldered, due to an increased probability of bridging.

The reflow soldering process involves applying solder paste to a board, followed by component placement and exposure to a temperature profile. Leaded packages, packages with solder balls, and leadless packages are all reflow solderable.

Key characteristics in both wave and reflow soldering are:

- Board specifications, including the board finish, solder masks and vias
- Package footprints, including solder thieves and orientation
- The moisture sensitivity level of the packages
- Package placement
- Inspection and repair
- Lead-free soldering versus SnPb soldering

17.3 Wave soldering

Key characteristics in wave soldering are:

- Process issues, such as application of adhesive and flux, clinching of leads, board transport, the solder wave parameters, and the time during which components are exposed to the wave
- Solder bath specifications, including temperature and impurities

17.4 Reflow soldering

Key characteristics in reflow soldering are:

- Lead-free versus SnPb soldering; note that a lead-free reflow process usually leads to higher minimum peak temperatures (see [Figure 21](#)) than a SnPb process, thus reducing the process window
- Solder paste printing issues including smearing, release, and adjusting the process window for a mix of large and small components on one board
- Reflow temperature profile; this profile includes preheat, reflow (in which the board is heated to the peak temperature) and cooling down. It is imperative that the peak temperature is high enough for the solder to make reliable solder joints (a solder paste characteristic). In addition, the peak temperature must be low enough that the packages and/or boards are not damaged. The peak temperature of the package depends on package thickness and volume and is classified in accordance with [Table 10](#) and [11](#)

Table 10. SnPb eutectic process (from J-STD-020C)

Package thickness (mm)	Package reflow temperature (°C)	
	Volume (mm ³)	
	< 350	≥ 350
< 2.5	235	220
≥ 2.5	220	220

Table 11. Lead-free process (from J-STD-020C)

Package thickness (mm)	Package reflow temperature (°C)		
	Volume (mm ³)		
	< 350	350 to 2000	> 2000
< 1.6	260	260	260
1.6 to 2.5	260	250	245
> 2.5	250	245	245

Moisture sensitivity precautions, as indicated on the packing, must be respected at all times.

Studies have shown that small packages reach higher temperatures during reflow soldering, see [Figure 21](#).

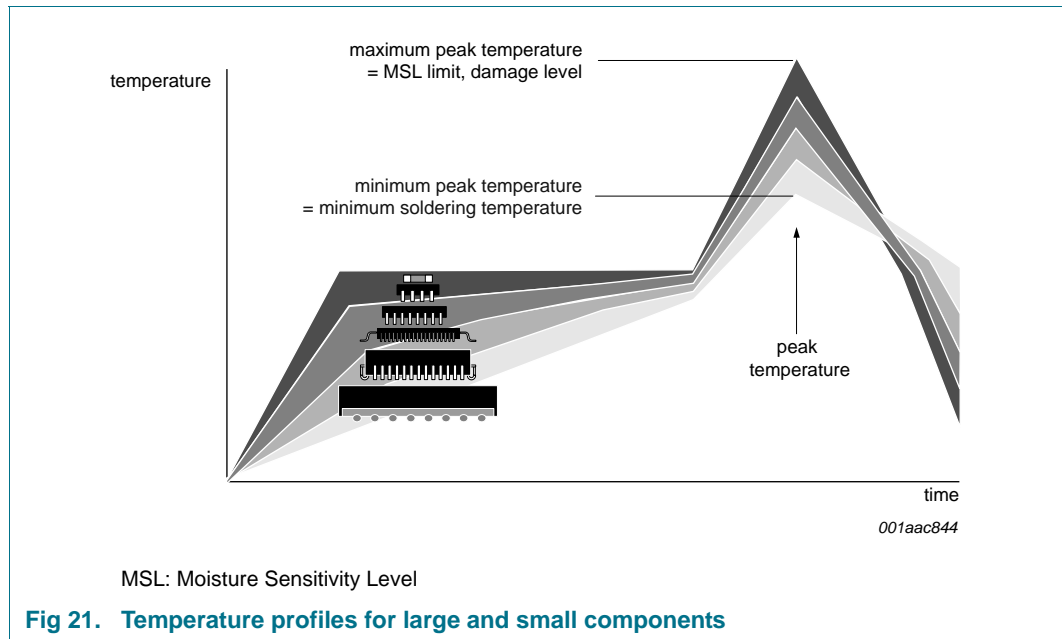

For further information on temperature profiles, refer to Application Note AN10365 “Surface mount reflow soldering description”.

18. Abbreviations

Table 12. Abbreviations

Acronym	Description
AMPS	Advanced Mobile Phone System
ASK	Amplitude Shift Keying
CMOS	Complementary Metal-Oxide Semiconductor
DECT	Digital European Cordless Telephone
ESD	ElectroStatic Discharge
FM	Frequency Modulation
FSK	Frequency Shift Keying
IF	Intermediate Frequency
LAN	Local Area Network
LC	inductor-capacitor filter
RF	Radio Frequency
RSSI	Received Signal Strength Indicator
SINAD	Signal-to-Noise-And-Distortion ratio
TACS	Total Access Communication System
TTL	Transistor-Transistor Logic
UHF	Ultra High Frequency
VHF	Very High Frequency

19. Revision history

Table 13. Revision history

Document ID	Release date	Data sheet status	Change notice	Supersedes
SA58641 v.2	20120309	Product data sheet	-	SA58641 v.1
Modifications:	<ul style="list-style-type: none">• The format of this data sheet has been redesigned to comply with the new identity guidelines of NXP Semiconductors.• Legal texts have been adapted to the new company name where appropriate.• Symbols and parameter descriptions are updated to conform to new presentation standards (values unchanged).• Section 1 “General description”, second paragraph, first sentence: changed from “... down to 2.7 V.” to “... down to 3 V.”• Table 7 “Dynamic characteristics”:<ul style="list-style-type: none">– V_{CC} Min value changed from “4.5 V” to “3 V”.			
SA58641 v.1	20041216	Objective data	-	-

20. Legal information

20.1 Data sheet status

Document status ^{[1][2]}	Product status ^[3]	Definition
Objective [short] data sheet	Development	This document contains data from the objective specification for product development.
Preliminary [short] data sheet	Qualification	This document contains data from the preliminary specification.
Product [short] data sheet	Production	This document contains the product specification.

[1] Please consult the most recently issued document before initiating or completing a design.

[2] The term 'short data sheet' is explained in section "Definitions".

[3] The product status of device(s) described in this document may have changed since this document was published and may differ in case of multiple devices. The latest product status information is available on the Internet at URL <http://www.nxp.com>.

20.2 Definitions

Draft — The document is a draft version only. The content is still under internal review and subject to formal approval, which may result in modifications or additions. NXP Semiconductors does not give any representations or warranties as to the accuracy or completeness of information included herein and shall have no liability for the consequences of use of such information.

Short data sheet — A short data sheet is an extract from a full data sheet with the same product type number(s) and title. A short data sheet is intended for quick reference only and should not be relied upon to contain detailed and full information. For detailed and full information see the relevant full data sheet, which is available on request via the local NXP Semiconductors sales office. In case of any inconsistency or conflict with the short data sheet, the full data sheet shall prevail.

Product specification — The information and data provided in a Product data sheet shall define the specification of the product as agreed between NXP Semiconductors and its customer, unless NXP Semiconductors and customer have explicitly agreed otherwise in writing. In no event however, shall an agreement be valid in which the NXP Semiconductors product is deemed to offer functions and qualities beyond those described in the Product data sheet.

20.3 Disclaimers

Limited warranty and liability — Information in this document is believed to be accurate and reliable. However, NXP Semiconductors does not give any representations or warranties, expressed or implied, as to the accuracy or completeness of such information and shall have no liability for the consequences of use of such information. NXP Semiconductors takes no responsibility for the content in this document if provided by an information source outside of NXP Semiconductors.

In no event shall NXP Semiconductors be liable for any indirect, incidental, punitive, special or consequential damages (including - without limitation - lost profits, lost savings, business interruption, costs related to the removal or replacement of any products or rework charges) whether or not such damages are based on tort (including negligence), warranty, breach of contract or any other legal theory.

Notwithstanding any damages that customer might incur for any reason whatsoever, NXP Semiconductors' aggregate and cumulative liability towards customer for the products described herein shall be limited in accordance with the *Terms and conditions of commercial sale* of NXP Semiconductors.

Right to make changes — NXP Semiconductors reserves the right to make changes to information published in this document, including without limitation specifications and product descriptions, at any time and without notice. This document supersedes and replaces all information supplied prior to the publication hereof.

Suitability for use — NXP Semiconductors products are not designed, authorized or warranted to be suitable for use in life support, life-critical or safety-critical systems or equipment, nor in applications where failure or malfunction of an NXP Semiconductors product can reasonably be expected to result in personal injury, death or severe property or environmental damage. NXP Semiconductors and its suppliers accept no liability for inclusion and/or use of NXP Semiconductors products in such equipment or applications and therefore such inclusion and/or use is at the customer's own risk.

Applications — Applications that are described herein for any of these products are for illustrative purposes only. NXP Semiconductors makes no representation or warranty that such applications will be suitable for the specified use without further testing or modification.

Customers are responsible for the design and operation of their applications and products using NXP Semiconductors products, and NXP Semiconductors accepts no liability for any assistance with applications or customer product design. It is customer's sole responsibility to determine whether the NXP Semiconductors product is suitable and fit for the customer's applications and products planned, as well as for the planned application and use of customer's third party customer(s). Customers should provide appropriate design and operating safeguards to minimize the risks associated with their applications and products.

NXP Semiconductors does not accept any liability related to any default, damage, costs or problem which is based on any weakness or default in the customer's applications or products, or the application or use by customer's third party customer(s). Customer is responsible for doing all necessary testing for the customer's applications and products using NXP Semiconductors products in order to avoid a default of the applications and the products or of the application or use by customer's third party customer(s). NXP does not accept any liability in this respect.

Limiting values — Stress above one or more limiting values (as defined in the Absolute Maximum Ratings System of IEC 60134) will cause permanent damage to the device. Limiting values are stress ratings only and (proper) operation of the device at these or any other conditions above those given in the Recommended operating conditions section (if present) or the Characteristics sections of this document is not warranted. Constant or repeated exposure to limiting values will permanently and irreversibly affect the quality and reliability of the device.

Terms and conditions of commercial sale — NXP Semiconductors products are sold subject to the general terms and conditions of commercial sale, as published at <http://www.nxp.com/profile/terms>, unless otherwise agreed in a valid written individual agreement. In case an individual agreement is concluded only the terms and conditions of the respective agreement shall apply. NXP Semiconductors hereby expressly objects to applying the customer's general terms and conditions with regard to the purchase of NXP Semiconductors products by customer.

No offer to sell or license — Nothing in this document may be interpreted or construed as an offer to sell products that is open for acceptance or the grant, conveyance or implication of any license under any copyrights, patents or other industrial or intellectual property rights.

Export control — This document as well as the item(s) described herein may be subject to export control regulations. Export might require a prior authorization from competent authorities.

Non-automotive qualified products — Unless this data sheet expressly states that this specific NXP Semiconductors product is automotive qualified, the product is not suitable for automotive use. It is neither qualified nor tested in accordance with automotive testing or application requirements. NXP Semiconductors accepts no liability for inclusion and/or use of non-automotive qualified products in automotive equipment or applications.

In the event that customer uses the product for design-in and use in automotive applications to automotive specifications and standards, customer (a) shall use the product without NXP Semiconductors' warranty of the product for such automotive applications, use and specifications, and (b) whenever customer uses the product for automotive applications beyond

NXP Semiconductors' specifications such use shall be solely at customer's own risk, and (c) customer fully indemnifies NXP Semiconductors for any liability, damages or failed product claims resulting from customer design and use of the product for automotive applications beyond NXP Semiconductors' standard warranty and NXP Semiconductors' product specifications.

Translations — A non-English (translated) version of a document is for reference only. The English version shall prevail in case of any discrepancy between the translated and English versions.

20.4 Trademarks

Notice: All referenced brands, product names, service names and trademarks are the property of their respective owners.

21. Contact information

For more information, please visit: <http://www.nxp.com>

For sales office addresses, please send an email to: salesaddresses@nxp.com

22. Contents

1	General description	1
2	Features and benefits	1
3	Applications	2
4	Ordering information	2
5	Block diagram	2
6	Pinning information	3
6.1	Pinning	3
6.2	Pin description	3
7	Functional description	4
8	Internal circuitry	5
9	Limiting values	8
10	Thermal characteristics	8
11	Static characteristics	8
12	Dynamic characteristics	9
13	Performance curves	10
14	Application information	14
15	Test information	17
16	Package outline	19
17	Soldering of SMD packages	20
17.1	Introduction to soldering	20
17.2	Wave and reflow soldering	20
17.3	Wave soldering	20
17.4	Reflow soldering	21
18	Abbreviations	22
19	Revision history	23
20	Legal information	24
20.1	Data sheet status	24
20.2	Definitions	24
20.3	Disclaimers	24
20.4	Trademarks	25
21	Contact information	25
22	Contents	26

Please be aware that important notices concerning this document and the product(s) described herein, have been included in section 'Legal information'.

© NXP B.V. 2012.

All rights reserved.

For more information, please visit: <http://www.nxp.com>

For sales office addresses, please send an email to: salesaddresses@nxp.com

Date of release: 9 March 2012

Document identifier: SA58641